

American Megatrends, Inc.
80486 Voyager LC
Motherboard
User's Guide

MAN-661
4/27/01

All rights reserved.
American Megatrends, Inc.
6145F Northbelt Parkway
Norcross, GA 30071

This publication contains proprietary information which is protected by copyright. No part of this publication may be reproduced, transcribed, stored in a retrieval system, translated into any language or computer language, or transmitted in any form whatsoever without the prior written consent of the publisher, American Megatrends, Inc.

Limited Warranty

Buyer agrees if this product proves to be defective, that American Megatrends, Inc. is only obligated to replace or refund the purchase price of this product at American Megatrend's discretion according to the terms and conditions of the warranty card accompanying the American Megatrends Super Voyager LC motherboard. American Megatrends shall not be liable in tort or contract for any loss or damage, direct, incidental or consequential. Please see the Warranty Registration Card shipped with this product for full warranty details.

Limitations of Liability

In no event shall American Megatrends be held liable for any loss, expenses, or damages of any kind whatsoever, whether direct, indirect, incidental, or consequential, arising from the design or use of this product or the support materials provided with the product.

Trademarks

American Megatrends acknowledges the following trademarks:

Intel and i486 are registered trademarks of Intel Corporation.
MS-DOS, Xenix, and Microsoft are registered trademarks of Microsoft Corporation.
IBM, AT, VGA, OS/2, and EGA are registered trademarks of International Business Machines Corporation. XT and CGA are trademarks of International Business Machines Corporation.
Fujitsu is a registered trademark of Fujitsu America, Inc.
Hitachi is a registered trademark of Hitachi America, Ltd.
FasMath is a trademark of Cyrix Corporation.
Motorola is a registered trademark of Motorola Corporation.
Oki is a registered trademark of Oki America, Inc.
NEC is a registered trademark of NEC Corporation.
Samsung is a registered trademark of Samsung Electronics Corporation.
Siemens is a trademark of Siemens Corporation.
Mitsubishi is a registered trademark of Mitsubishi Electronics of America.
Unix is a registered trademark of American Telephone and Telegraph Company Bell Laboratories.

Preface

Weitek is a trademark of Weitek, Inc.
QEMM is a trademark of Quarterdeck Office Systems.
Toshiba is a registered trademark of Kabushiki Kaisha Toshiba.
Chips and Technologies, NEAT, and CHIPSet are registered trademarks of Chips and Technologies Incorporated.

Revision History

7/15/92 Initial printing.
8/92 Errata sheet published.
3/26/93 Minor revisions to manual.

Table of Contents

Chapter 1 Introduction	1
Specifications	2
Microprocessor	2
Heat Sink for 50 MHz CPUs	2
Processor Speeds	2
Main Memory	2
Cache Memory	3
Cache Memory SRAM Type	3
Built-in Battery	3
External Battery	3
Real Time Clock	3
ROM	4
Shadow RAM	4
Upgrade Socket	4
System BIOS	4
CMOS RAM	4
Math Coprocessor	4
System Support Functions	5
Keyboard	6
CPU Socket	6
Speaker	6
Expansion Slots	6
Chapter 2 Installation	7
Unpacking	7
Installation Steps	9
Step 1 Set Switch and Jumper Options	10
Step 2 Install Memory	13
Step 3 Install Processor	16
Step 4 Install the Motherboard	18
Step 5 Connect the Power Supply	20
Step 6 Connect the Keyboard	22
Step 7 Connect Cables	23
Step 8 Install Adapter Cards	28
Step 9 Perform Initial Test and Configuration	30
Chapter 3 BIOS Power-On Self Test (POST)	31
AMIBIOS Displayed Error Messages	33
Chapter 4 AMIBIOS	37
Section 1 Running AMIBIOS Setup	39
Setup Keys	40
Auto Configuration With BIOS Defaults	41
Write to CMOS and Exit	42
Do Not Write to CMOS RAM and Exit	42

Preface

Table of Contents, Continued

Chapter 4 AMIBIOS, cont'd	
Section 2 STANDARD CMOS SETUP	43
Date And Day Configuration	44
Hard Disk Configuration	45
Hard Disk Parameter Table	46
Floppy Drive A and Floppy Drive B:	48
Primary Display	48
Keyboard	48
Section 3 ADVANCED CMOS SETUP	49
Typematic Rate Programming, Rate, and Delay	50
Above 1 MB Memory Test	50
System Boot Up Num Lock	51
Floppy Drive Seek At Boot	51
System Boot Up CPU Speed	52
External Cache Memory	52
Password Checking Option	52
Video ROM Shadow	52
C000 Shadow RAM Cacheable	52
Section 4 ADVANCED CHIPSET SETUP	53
8-bit AT Cycle Wait State	54
16-bit AT Cycle Wait State	54
Cache Write Back	54
Non-Cacheable Block-1	54
Non-Cacheable Block-1 Size	54
Non-Cacheable Block-1 Base	54
Section 5 AMIBIOS Password Support	55
Section 6 Hard Disk Utility	57
When to Use AMIBIOS Hard Disk Utilities	58
Hard Disk Format Utility	59
Auto Interleave Utility	61
Hard Disk Utility Error Messages	63
Appendix A Upgrading to 256 KB Cache	65
Cache Diagram	66
Appendix B Heat Dissipation	67
Appendix C Using QEMM®	69
Appendix D Miscellaneous Series 61 BIOS Data	71
BIOS Setup Options	71
BIOS Features	71
Advanced BIOS Features	72
Index	73

Preface

To the OEM, VAR, or System Integrator

Thank you for purchasing the high performance Series 61 Super Voyager LC AT-compatible motherboard from American Megatrends. It is assumed that you have also licensed the rights to use the American Megatrends technical documentation for the Super Voyager LC. This manual was written for customers who are system integrators, VARs, or OEMs to assist in the proper installation and operation of the Super Voyager LC motherboard. This manual is not meant to be read by the computer owner who purchases a computer with the Super Voyager LC motherboard. It is assumed that you, the computer manufacturer, will use this manual as a sourcebook of information, and that parts of this manual will be included in the computer owner's manual.

Technical Support

If a Super Voyager LC motherboard fails to operate as described or you are in doubt about a configuration option, please call American Megatrends technical support at 404-246-8600.

Acknowledgments

This manual was written by Uma S. Mondal, Robert Cheng, and Paul Narushoff.

Chapter 1

Introduction

The American Megatrends Series 61 80486 Super Voyager LC is an AT®-compatible motherboard, approximately 8.55 inches wide by 13 inches in length. It is similar in size to a standard baby AT motherboard.

The mounting hole locations allow this motherboard to be used with a baby AT chassis. The height of the board components is no more than 1½ inches, but you should allow 2 inches of clearance for the power supply connectors. See the following graphic for more information on height requirements.

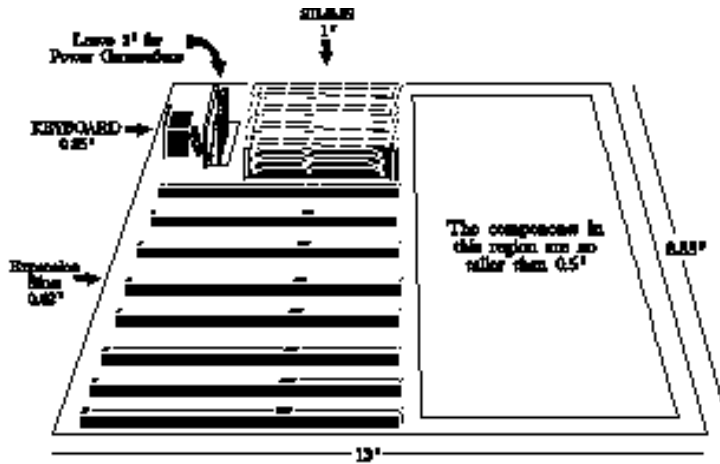

Series 61 Super Voyager LC

Specifications

Microprocessor

The Super Voyager LC motherboard uses either :

- an Intel® 80486DX operating at 25, 33, or 50 MHz,
 - an Intel 80486DX-2 operating at 25 or 33 MHz, or
 - an Intel 80486SX or P23T processor operating at 20 or 25 MHz.
-

Heat Sink for 50 MHz CPUs

The Series 61 Super Voyager LC motherboard has a heat sink for all motherboards equipped with an Intel 80486DX 50 MHz processor to help dissipate heat. See Appendix B on page 69 for additional information about heat dissipation.

Processor Speeds

The microprocessor has two clock speeds, high and low. High speed is set at time of manufacture to the processor speed (20, 25, 33, or 50 MHz). Low speed is simulated by turning off the external and internal cache. The clock speeds can be changed via the <Ctrl> <Alt> <+> and <Ctrl> <Alt> <-> keychords or via the Turbo switch. The keychords can be changed via AMIBCP.

Main Memory

The Super Voyager LC supports up to 32 MB via two banks of 4 MB x 9 SIMMs on the motherboard. 256 KB x 9 and 1 MB x 9 SIMMs can also be used. Each bank consists of four SIMM slots.

70 ns SIMMs are used for all processor speeds.

Cache Memory

The external cache memory size is 64 or 256 KB with:

- 2-1-1-1 burst access with 0 wait states at 20, 25, or 33 MHz operation, and
- 3-2-2-2 burst access with 1 write wait state at 50 MHz operation.

32 MB of system memory can be cached if 256 KB of cache memory is installed. 16 MB of system RAM can be cached if 64 KB of cache memory is available. There are 0 wait states for cache memory read and write at 20, 25, or 33 MHz and 1 wait state for both read and write at 50 MHz. Burst mode is supported for caching.

Cache Memory SRAM Type

33 and 50 MHz Super Voyager LC motherboards use 15 ns SRAM for cache memory. 20 and 25 MHz Super Voyager LC motherboards use 20 ns SRAM.

Built-in Battery

The Super Voyager LC motherboard has a built-in rechargeable 3.6 volt NiCad battery. An optional external battery is supported.

External Battery

The Super Voyager LC motherboard supports an optional external battery, which is connected to J1.

Real Time Clock

The Super Voyager LC has a standard crystal-controlled AT-type real time clock. The real time clock is powered by a rechargeable onboard battery .

ROM

The Super Voyager LC has 64 KB of Read Only Memory (ROM) used for the system BIOS at F0000h.

Shadow RAM

The Super Voyager LC system BIOS is always shadowed from ROM to RAM. You can select video BIOS shadowing through AMIBIOS Setup. Video BIOS can be both shadowed and cached.

Upgrade Socket

The Super Voyager LC motherboard has a 169-pin LIF socket for an Intel 80487SX or future Intel Upgrade Processor, such as the P23T.

System BIOS

The Super Voyager LC uses a customize AMIBIOS with a built-in Setup configuration utility and hard disk drive utilities. Via AMIBIOS Setup, you can configure up to two user-definable hard disk drive types. You can easily configure systems with no video monitor, keyboard, or floppy disk drives in STANDARD CMOS SETUP.

CMOS RAM

The Super Voyager LC has 128 bytes of CMOS RAM to store system configuration data. CMOS RAM is backed by a rechargeable onboard battery.

Math Coprocessor

Super Voyager LCs equipped with an 80486SX support an optional Intel 80487SX math coprocessor.

System Support Functions

The Super Voyager LC supports all standard ISA functions and some nonstandard functions:

- seven Direct Memory Access (DMA) channels:
Channels 0 - 3 are used for 8-bit data transfer;
Channels 5 - 7 are used for 16-bit data transfers.
 - sixteen interrupt levels:
eleven levels of interrupt are supported, including:
IRQ3–IRQ7, IRQ9–13 IRQ12, IRQ14, and IRQ15.
 - three programmable timers, and a
 - system clock.
 - ability to access 32-, 16-, and 8-bit memory devices and
16- and 8-bit I/O devices.
 - standard ISA I/O port addresses: 0100h through 03FFh.
 - 24-bit memory addresses that can access 16 MB of
memory address space.
 - uses an *I/O channel check* to generate NMIs.
 - supports I/O wait state generation.
 - has an open bus structure that permits multiple
microprocessors to share system resources, including
system memory.
 - the bus operates at:
 - 8.00 MHz for 20 MHz motherboards,
 - 8.25 MHz for 33 MHz motherboards, and
 - 8.33 MHz for 25 or 50 MHz motherboards.
 - permits system memory refresh from channel
microprocessors.
-

Specifications, Continued

Keyboard

The Super Voyager LC has a standard five-pin DIN connector for an AT-compatible keyboard. The Super Voyager LC also has a keyboard lock function to prevent unauthorized access to the system.

CPU Socket

The Super Voyager LC has a 168-pin PGA socket designed to be occupied by an Intel 80486DX, 80486SX, or 80486DX-2 microprocessor.

Speaker

The Super Voyager LC has an attachment for an audio speaker.

Expansion Slots

The Super Voyager LC has eight 16-bit AT -compatible expansion slots.

Chapter 2

Installation

Unpacking

Step	Action
1	<p>Inspect the cardboard carton for obvious damage. If damaged, call American Megatrends Technical Support at 404-246-8600.</p> <p>Leave the Super Voyager LC motherboard in its original packing.</p>
2	<p>Perform all unpacking and installation procedures on a ground-connected anti-static mat. The operator should wear an anti-static wristband, grounded at the same point as the anti-static mat. Or use a sheet of conductive aluminum foil grounded through a 1 megohm resistor instead of the anti-static mat. Similarly, a strip of conductive aluminum foil wrapped around the wrist and grounded through a 1 megohm resistor serves the same purpose.</p>
3	<p>Inside the carton, the Super Voyager LC motherboard is packed in an anti-static bag, and sandwiched between sheets of sponge. Remove the sponge and remove the anti-static bag. Save the original packing material in case of reshipment.</p>
4	<p>Place the Super Voyager LC motherboard on a grounded anti-static surface component-side up.</p>
5	<p>Inspect the motherboard for damage. Do not apply power to the motherboard if it has been damaged.</p>
6	<p>Press down on all ICs mounted in sockets to verify proper seating.</p>
7	<p>If the motherboard is undamaged, it is ready to be installed.</p>

Series 61 Motherboard Layout

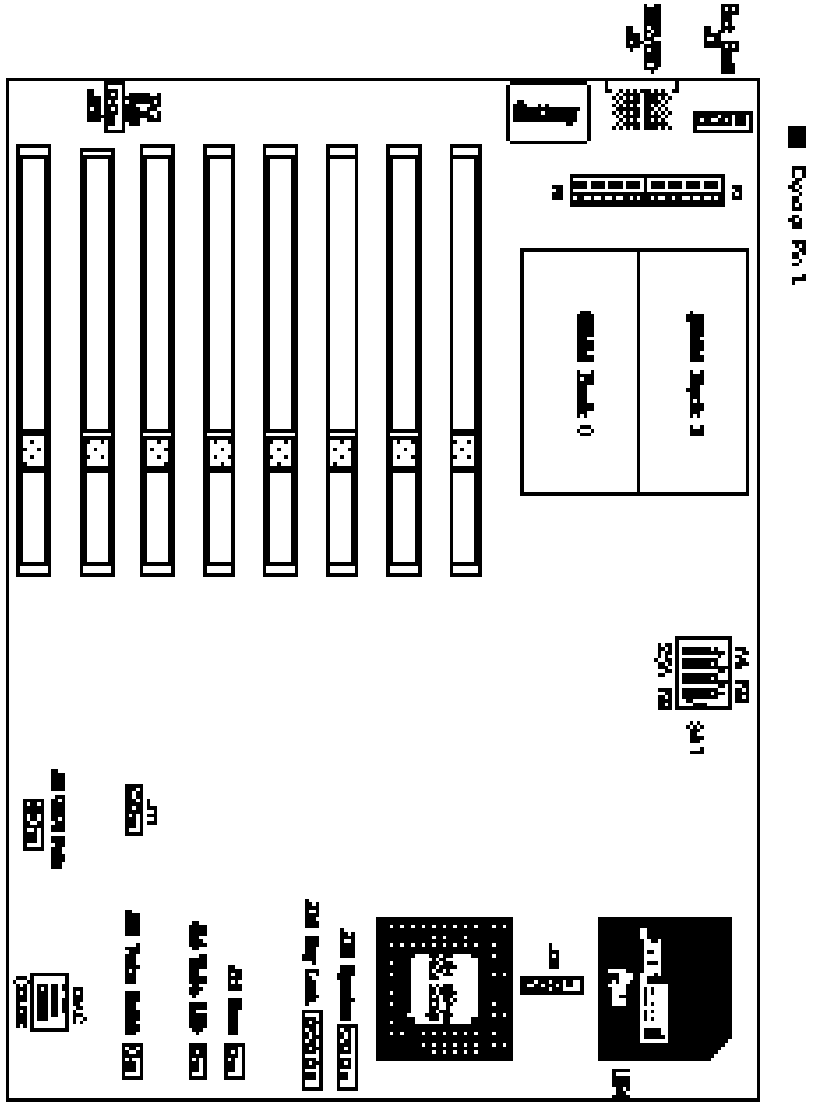

Installation Steps

The steps for assembling a system that has an 80486 Super Voyager LC motherboard are shown in the following table. Each step is discussed in detail in the following pages.

Step	Action	Turn to
1	Set switch and jumper options.	Page 11
2	Install memory.	Page 15
3	Install math coprocessor or upgradeable processor.	Page 18
4	Install motherboard.	Page 20
5	Connect the power supply.	Page 22
6	Connect the keyboard.	Page 24
7	Connect cables.	Page 25
8	Install adapter cards.	Page 30
9	Perform initial test and configuration.	Page 32

Standoffs and mounting screws are not supplied with the 80486 Super Voyager LC motherboard. These should be supplied with the chassis.

Step 1 Set Switch and Jumper Options

Set all user-configurable jumpers and switches before installing the motherboard. The Super Voyager LC has two switches and four jumpers:

SW1	Cache Memory Size Select
SW2	DIAG and Display
J12	Processor Type
J17	Clock Select
J23	Power Good Signal Select
J33	CMOS Drain

SW1 Cache Select

SW1 is a four-position two-bit DIP switch. See the graphic on page 9 for the location of SW1. If all four switches are OFF, 64 KB of cache memory is configured. 256 KB cache memory is configured if all switches are ON.

SW2 Diagnostics and Color

SW2 consist of two switches. The diagnostic switch is used for manufacturing diagnostics and should not be changed. The motherboard is shipped with this switch OFF. The switch should remain OFF.

The COL/MONO switch sets the type of video adapter card. This switch has no effect if an EGA or VGA adapter is used. This switch is factory-set to OFF for a monochrome display adapter. Set ON for a color graphics adapter (CGA).

Step 1 Set Switch and Jumper Options,

Continued

J12 Select Processor Type

J12 is a four-pin single-inline berg that selects the processor type. Pins 1-2 and 3-4 are shorted if the Super Voyager LC motherboard has an 80486DX or DX-2 microprocessor. Pins 2-3 are shorted if the motherboard has an 80486SX processor. See the following graphic.

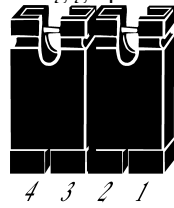

Select 486DX
Short pins 1-2 & 3-4

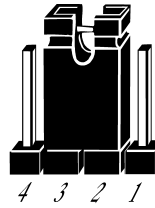

Select 486SX
Short pins 2-3

J17 Clock Select

J17 is a three-pin single-inline berg. Pins 1-2 are shorted if this Super Voyager LC has a 25, 33, or 50 MHz processor. Pins 2-3 are shorted if it has a 20 MHz processor. See the following graphic.



Select 20 MHz
Pins 2-3 Shorted

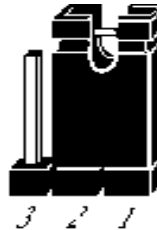

Select 25, 33,
or 50 MHz
Pins 1-2 Shorted

Super-Voyager LC Motherboard User's Guide

Step 1 Set Switch and Jumper Options,

Continued

J23 POWERGOOD Signal Source

J23 is a three-pin berg. Pins 1-2 are shorted if the Internal POWERGOOD signal is used. Pins 2-3 are shorted if an External POWERGOOD Signal is used.

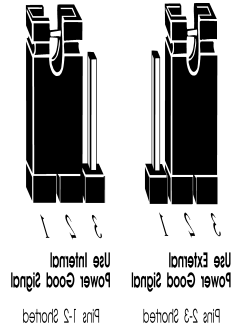

J33 CMOS RAM Drain

J33 is a three-pin single-inline berg. In normal operation, pins 1-2 are shorted. Short pins 2-3 to drain power from CMOS RAM, as shown in the following graphic.

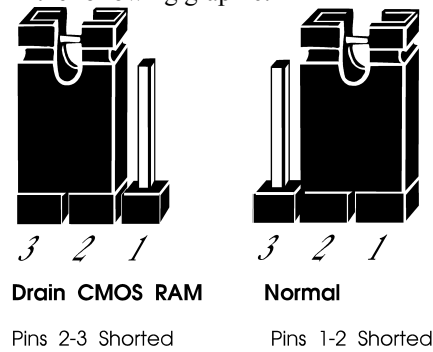

Step 1 Set Switch and Jumper Options,

Continued

J33 CMOS RAM Drain, cont'd

If you forget the system password, you must remove the battery to make sure that CMOS RAM is without power for at least 20 minutes so the current password will be erased from CMOS RAM.

J33 provides a quicker method for removing the password from CMOS RAM. By shorting pins 2-3 of J33, you can quickly drain CMOS RAM power to remove the old password. He then must run AMIBIOS Setup to reconfigure the system.

Step 2 Install Memory

The main memory subsystem on the Super Voyager LC motherboard consists of two 32-bit memory banks of four sockets each. Both banks house SIMM (Single In-line Memory Module) DRAM packages.

The SIMM banks accept 256 KB x 9, 1 MB x 9, or 4 MB x 9 bit SIMMs in the combinations shown below.

A SIMM bank must be completely filled if used. The motherboard memory configuration is automatically detected.

Bank0	Bank1	Total RAM
256 KB x 9	None	1 MB
256 KB x 9	256 KB x 9	2 MB
1 MB x 9	None	4 MB
1 MB x 9	1 MB x 9	8 MB
4 MB x 9	None	16 MB
4 MB x 9	4 MB x 9	32 MB

Step 2 Install Memory, Continued

Reporting Memory

The system memory configuration is reported by AMIBIOS as it boots and again in the BIOS System Configuration Screen displayed when AMIBIOS boots DOS.

If the system has up to 8 MB of RAM, the memory shown by AMIBIOS is 128 KB less than the total amount of memory installed because parts of the memory between 640K and 1 MB are used for system and video BIOS shadowing. If the system has 16 MB of RAM or more, the memory shown by AMIBIOS is 384 KB less than the total amount of memory installed.

Memory Features

- If both SIMM banks are filled, all memory is interleaved.
 - Fast page access is supported.
 - Burst support is provided.
 - Hidden refresh is supported.
 - if both SIMM banks are used, **Bank1 must be filled before Bank0.**
 - If only one SIMM bank is filled, it must be Bank0. Bank0 is the four SIMM sockets **nearest** the expansion slots.
 - Install SIMMs before installing adapter cards. Some of the SIMMs in Bank0 cannot be installed if an adapter card is in the adjacent expansion slot. Also, if adding SIMMs to Bank1 for the first time, remove the Bank0 SIMMs first.
-

Step 2 Install Memory, Continued

SIMM Part Numbers

Memory Type	Manufacturer	Part Number
256 K x 9	Siemens®	HYB514256AJ-70
1 MB x 9	Fujitsu®	MB85235-70
	Toshiba®	THM91070AS-70 THM91000AS-70
	Motorola®	MCM91000S-70 MCM91430S-70
	Okidata®	MSC2312A-704S9
	NEC®	MC-42100A9-70
	Samsung®	KMM591000AN-7
	Siemens	HYM910005-70
4 MB x 9	Motorola	MCM94000A-70
	Samsung	KMM594000A-70
	Okidata	MSC2340-70459

Installing SIMMs

Bank 0 and Bank 1 have four SIMM sockets each. These sockets can be filled with 256 KB x 9, 1 MB x 9, or 4 MB x 9 SIMMs. Use only one type of module to fill each bank.

Place the Super Voyager LC motherboard on an anti-static mat. With the component side of the SIMM facing you, firmly push the SIMM into the socket.

When properly inserted, the SIMM clicks in place as the latching pins engage, as shown below.

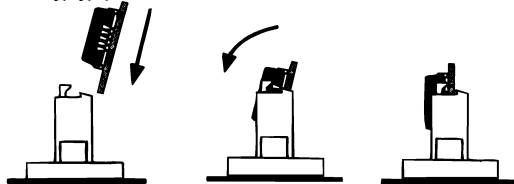

Step 3 Install Processor

For Use Only with 80487SX Math Coprocessor

The only math coprocessor that can be used on the Super Voyager LC motherboard is an Intel 80487SX. And it can be used only if the processor on the Super Voyager LC is an Intel 80486SX. It is installed in U54, the Intel Upgradable Processor socket. Make sure the 80487SX coprocessor speed is the same as the 80486SX speed (20 or 25 MHz).

Installing the 80487SX on the Motherboard

U54 is the empty 169-pin PGA socket between the cache memory and the microprocessor. An 80487SX can be installed if an 80486SX processor is present.

Pin 1 of the socket is on a chamfered corner that corresponds to pin 1 of the 80487SX, also on a chamfered corner. Check for bent pins on the 80487SX. Gently straighten any bent pins with a pair of pliers. Install the component in the socket. Align the pins and press the 80487SX firmly in the socket, making sure that pin 1 is aligned with pin 1 on U54. See the following figure.

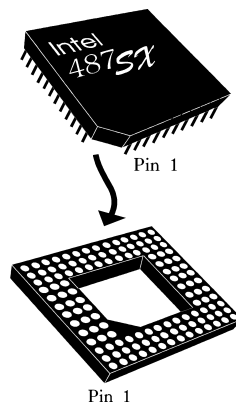

Step 3 Install Math Coprocessor, Continued

Test for Math Coprocessor

The AMIBIOS System Configuration screen shown at boot up indicates if a math coprocessor is configured. If the coprocessor is shown as Absent, reinstall the coprocessor, as follows .

Step	Action
1	Turn the power off.
2	Check the coprocessor orientation.
3	Press the chip firmly to make sure that it is properly inserted.
4	Visually inspect the coprocessor to make certain that all pins are connected.
5	Power the system up again. Call American Megatrends Technical Support at 404-246-8600 if still not configured.

Upgradeable Processor

U54 can also be used to install a 169-pin Intel upgradeable processor, such as an Intel P23T. The installation process is the same as installing an Intel 80487SX.

Step 4 Install the Motherboard

The mounting hole pattern on the Super Voyager LC motherboard is the same as the mounting hole pattern on a baby AT motherboard. See the following graphic .

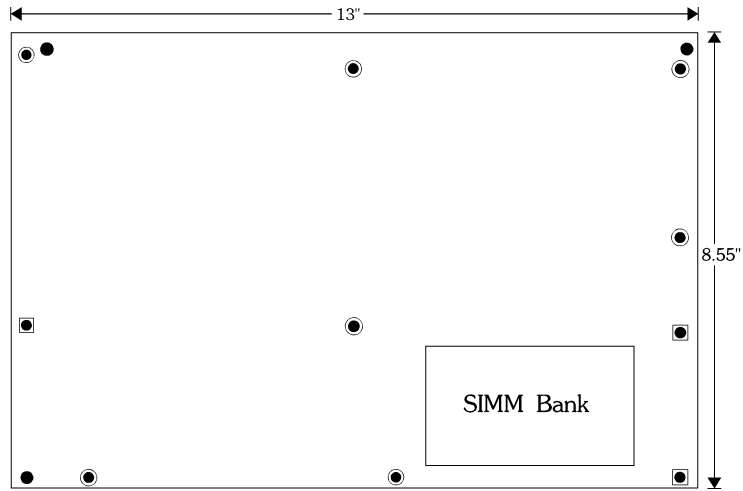

Legend: □ screw hole ○ Mounting hole

Step 4 Install the Motherboard, Continued

Perform the following steps to install the Super Voyager LC motherboard in a computer chassis. Refer to the graphic on the preceding page.

Step	Action
1	Make sure you are wearing an antistatic wristband. Place the chassis for the Super Voyager LC motherboard on an anti-static mat.
2	Connect the chassis to ground to avoid static damage during installation. Connect an alligator clip with a wire lead to any unpainted part of the chassis. Ground the other end of the lead at the same point as the mat and the wristband.
3	Rotate the chassis so that the front is to the right, and the rear is to the left. The side facing you is where the motherboard is mounted. The power supply is mounted near the back end of the chassis. See the graphic on the preceding page.
4	Push four nylon standoffs from the solder side of the motherboard in the holes provided for them. The standoffs lock in place.
5	Find the slots provided for the standoffs on the chassis. Hold the Super Voyager LC motherboard, component-side up, with the edge with three standoffs toward you, and the edge with the power supply connector away from you. The edge connectors for the adapter cards should be on the left.
6	Carefully slide the motherboard into the chassis. Make certain that the standoffs fit the slots provided for them. If the standoffs are properly locked, the motherboard should not slide. It should also rest level with the chassis. The far edge should fit the slots in the plastic clips.
7	Place the two mounting screws in the holes provided for them and tighten them. If necessary, shift the motherboard slightly to align the mounting holes on the motherboard with the holes on the chassis. Refer to the Super Voyager LC graphic shown on page 9.

Standoffs and mounting screws are not supplied with the 80486 Super Voyager LC motherboard. These should be supplied with the chassis.

Step 5 Connect the Power Supply

The power supply specifications should match the physical configuration of the chassis.

Make sure that the power switch is Off before installation.

Before attaching all components, make sure that the proper voltage has been selected. Power supplies often can run on a wide range of voltages, but must be set (usually with a switch) to the proper range.

Use at least a 200 watt (or larger) power supply. It should have built-in filters to suppress radiated emissions.

The power supply is connected to P2 and P3 on the motherboard. The connectors should be keyed to prevent connecting the plugs to the wrong connectors. The keys on the connector must be cut to fit on some power supplies. See the following graphic.

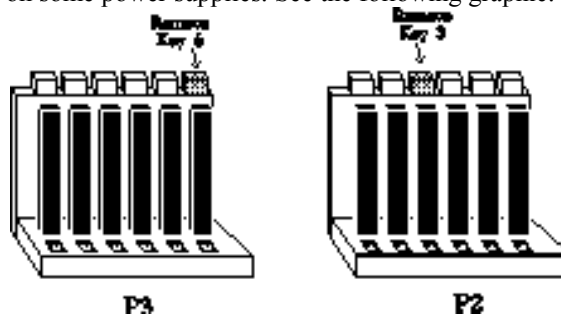

Step 5 Connect the Power Supply, Continued

See the following figure for the location of connectors P2 and P3.

AT-compatible power supplies have two six-pin connectors that are inserted in P2 and P3.

The six-pin connector with 3 red wires and 2 black wires is connected to P3 and the remaining six-pin connector is connected to P2.

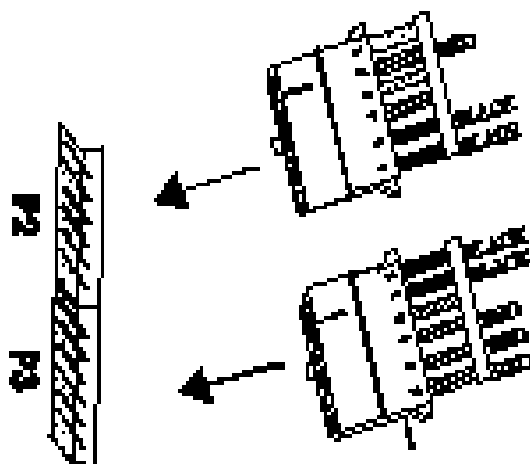

Step 6 Connect the Keyboard

The keyboard connector is a five-pin DIN socket (see the graphic below) and is labeled KEYBRD and J3 on the motherboard. It accepts a standard AT-compatible keyboard.

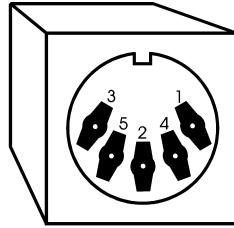

5-Pin Keyboard Connector

Pin	Assignments
1	Keyboard clock
2	Keyboard data
3	Not used
4	Ground
5	VCC

Step 7 Connect Cables

When connecting chassis connectors to the motherboard, make sure you attach the correct end.

Most connector wires are color-coded. Match the color of the wires leaving pin 1 on the switch or LED to pin 1 on the connector end.

There may be more than one connector with the same color-coded wires. If so, follow the wire to the switch or LED.

Pin 1 of all connectors is labeled on the graphic on page 9 as well as on the Super Voyager LC motherboard to identify the pin orientation when plugging in cables.

Summary of Connectors

The following cables should be connected to the motherboard from the chassis:

- Reset Switch cable to J22,
 - Speaker cable to J15,
 - Keyboard Lock cable to J18,
 - Turbo LED cable to J16,
 - Turbo switch cable to J21,
 - External Battery Connector to J1,
 - Diag LED connector.
-

J22 Reset Button Connector

J22 is a two-pin single-inline berg. A hard reset is done when the Reset button is pressed. Pin 1 is ground and Pin 2 is Hard Reset. See the following illustration.

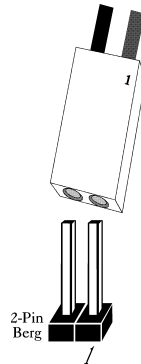

J15 Speaker Cable

J15 is a 4 pin single-in-line berg. AMIBIOS signals hardware problems through the speaker. Pin 1 on the motherboard is labeled by a plus (+).

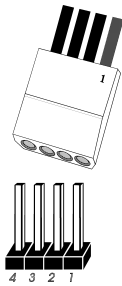

Pin	Description
1	VCC
2	Key
3	Ground
4	Data Out

Step 7 Connect Cables, Continued

J18 Keyboard Lock Connector

J18 is a five-pin single-inline berg. The keyboard lock allows you to lock the keyboard, protecting the system from unauthorized use. This connector is keyed with a blank hole. Pin 1 on the motherboard is labeled with a plus (+) sign. The connector and the J18 pinout is shown below.

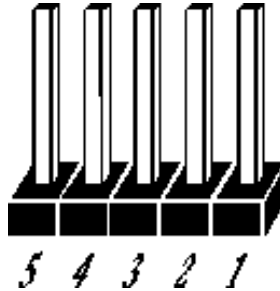

J18 Pinout

Pin	Description
1	LED power
2	Key
3	Ground
4	Keyboard Lock
5	Ground

Step 7 Connect Cables, Continued

J16 Turbo LED

J16 is a 2-pin berg that connects to the Turbo LED via a cable. The LED lights when the board is running at high speed. Connect the Turbo LED to J16 as shown below.

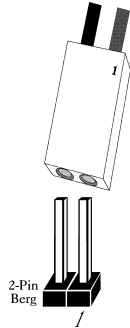

J21 Turbo Switch

J21 is a two-pin berg that connects to the Turbo switch mounted on the chassis via a cable, as shown below. The Turbo LED switch is bipolar. You can select Low or High speed by pressing the Turbo switch.

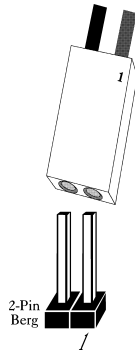

Step 7 Connect Cables, Continued

J1 External Battery Connector

The Super Voyager LC has a built-in rechargeable battery on the motherboard and does not need an external battery. However, an external battery can be used with the Super Voyager LC. Connect the external battery to J1.

If you connect an external battery to J1, the built-in battery on the motherboard is automatically electrically isolated.

J1 is a four-pin berg that connects to a 6-volt external battery. The positive (+) terminal, indicated by a red wire, connects to the pin labeled +. The J1 pinout is:

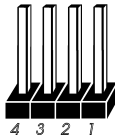
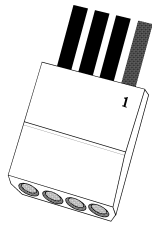

Pin	Description
1	6 Volt
2	Not use
3	Not use
4	Ground

Step 8 Install Adapter Cards

The Super Voyager LC has eight 16-bit slots. The 16-bit slots can accept either 8- or 16-bit ISA (XT- or AT-compatible) adapter cards.

16-Bit ISA Extension Pinout

The following 16-bit pins are an extension of the 8-bit board layout and are used in conjunction with the 8-bit board standard pins.

Pin	Use	Pin	Use
C1	SBHE-	D1	MEMCS16-
C2	LA23	D2	IOCS16-
C3	LA22	D3	IRQ10
C4	LA21	D4	IRQ11
C5	LA20	D5	IRQ12
C6	LA19	D6	IRQ13
C7	LA18	D7	IRQ14
C8	LA17	D8	DACK0-
C9	MEMR-	D9	DREQ0
C10	MEMW-	D10	DACK5-
C11	SD08	D11	DREQ5
C12	SD09	D12	DACK6-
C13	SD10	D13	DREQ6
C14	SD11	D14	DACK7-
C15	SD12	D15	DREQ7
C16	SD13	D16	+5
C17	SD14	D17	MASTER-
C18	SD15	D18	GND

Step 8 Install Adapter Cards, Continued

8-Bit ISA Slot Pinout

Pin	Use	Pin	Use
A1	IOCHCK-	B1	GND
A2	SD07	B2	RSTDRV
A3	SD06	B3	+5
A4	SD05	B4	IRQ9
A5	SD04	B5	-5
A6	SD03	B6	DREQ2
A7	SD02	B7	-12
A8	SD01	B8	OWS-
A9	SD00	B9	+12
A10	IOCHRDY	B10	GND
A11	AEN	B11	SMEMW-
A12	SA19	B12	SMEMR-
A13	SA18	B13	IOW-
A14	SA17	B14	IOR-
A15	SA16	B15	DACK3-
A16	SA15	B16	DREQ3
A17	SA14	B17	DACK1-
A18	SA13	B18	DREQ1
A19	SA12	B19	REF-
A20	SA11	B20	SYSCLK
A21	SA10	B21	IRQ7
A22	SA09	B22	IRQ6
A23	SA08	B23	IRQ5
A24	SA07	B24	IRQ4
A25	SA06	B25	IRQ3
A26	SA05	B26	DACK2-
A27	SA04	B27	T/C
A28	SA03	B28	BALE
A29	SA02	B29	+5
A30	SA01	B30	OSC
A31	SA00	B31	GND

Step 9 Perform Initial Test and Configuration

Before powering up the system to perform the initial test, review the following checklist:

- make sure that all adapter cards are seated properly,
 - make sure all connectors are properly seated,
 - if a math coprocessor or Upgradable Processor is used, make sure it is seated properly,
 - make sure there are no screws or other foreign material on the motherboard,
 - plug the system into a surge-protected power strip, and
 - make sure blank back panels are installed on the back of the chassis to minimize RF emissions.
-

Start the Test

Plug everything in and turn on the switch. If there are any signs of a problem, turn off the unit immediately. Reinstall the connectors. Call Technical Support at 404-246-8600 if there are problems. If the system operates normally, a memory display should appear on the monitor. AMIBIOS POST should run. POST beeps or displays error messages is unsuccessful.

Configure the System

Run AMIBIOS Setup to provide the requested information and save the configuration data in CMOS RAM. The system then resets, runs POST, and boots the operating system. See page 45 for a description of AMIBIOS STANDARD CMOS SETUP options.

In Case of Errors

If the system beeps, a serious problem exists with the system configuration or hardware. Beep codes (see page 34) indicate a bad component. If AMIBIOS is able to initialize the system video monitor, messages are displayed on the screen. These messages are described on page 35. Recheck the system configuration or the connections to assure that the installation procedures were followed.

Chapter 3

BIOS Power-On Self Test (POST)

Overview

AMIBIOS provides all IBM-standard POST routines as well as enhanced American Megatrends routines. AMIBIOS POST supports CPU internal diagnostics. POST codes are accessible via the Manufacturing Test Port (I/O Port 80h).

POST Phases

When the system is powered on, AMIBIOS executes POST routines. The POST phases are:

System Test and Initialization (test and initialize motherboards for normal operations) and

System Configuration Verification (compare defined configuration with hardware actually installed).

BIOS Error Reporting

If...	Then...
the error occurs before the display device is initialized,	a series of beeps sound. Beep codes indicate that a fatal error has occurred. The AMIBIOS Beep Codes are described on the next page.
the error occurs after the display device is initialized,	the error message is displayed. Displayed BIOS error messages are explained on page 35. A prompt to press <F1> can also appear with displayed error messages.

Beep Codes

Fatal errors, listed below, are communicated through a series of audible beeps. All errors except Beep Code 8 are fatal. Fatal errors halt the boot process. In most cases, displayed errors allow the system to continue. AMIBIOS displayed errors are described on page 35.

Beep Code	Error message	Description
1 beep	Refresh Failure	The memory refresh circuitry on the motherboard is faulty.
2 beeps	Parity Error	A parity error was detected in the base memory (the first 64 KB block) of memory.
3 beeps	Base 64 KB Memory Failure	Memory failure in first 64 KB.
4 beeps	Timer Not Operational	A memory failure occurred within the first 64 KB of memory. Or Timer 1 on the motherboard is not functioning.
5 beeps	Processor error	The CPU (Central Processing Unit) has generated an error.
6 beeps	8042 - Gate A20 Failure	Gate A20 on the keyboard controller (8042) allows the CPU to operate in protected mode. AMIBIOS is not able to switch the CPU to protected mode.
7 beeps	Processor Exception Interrupt Error	The CPU generated an exception interrupt.
8 beeps	Display Memory Read/Write Error	The system video adapter is either missing or its memory is faulty. This is not a fatal error.
9 beeps	ROM Checksum Error	The ROM checksum does not match the value encoded in AMIBIOS.
10 beeps	CMOS Shutdown Register Read/Write Error	The shutdown register for CMOS RAM has failed.
11 beeps	Cache memory bad — do not enable cache	The cache memory test failed. Cache memory is disabled.

AMIBIOS Displayed Error Messages

Error message are displayed as follows:

ERROR Message Line 1
ERROR Message Line 2

followed by

Press the <F1> key to continue

and the system halts. The system does not halt if Wait for <F1> If Any Error in ADVANCED CMOS SETUP is Disabled. If a second message appears, it is:

RUN SETUP UTILITY.

Error Message	Explanation
8042 Gate-A20 Error	Gate A20 on the keyboard controller (8042) is not working. Replace the 8042.
Address Line Short!	An error has occurred in the address decoding circuitry on the motherboard.
C: Drive Error	Drive C: may be missing. If installed, run the Hard Disk Utility to correct this problem. Also, check the C: hard disk type in STANDARD CMOS SETUP to make sure that the hard disk drive type is correct.
C: Drive Failure	No response from hard disk drive C:. Replace drive C:.
Cache Memory Bad, Do Not Enable Cache!	Cache memory on the motherboard is defective. Test cache memory with AMIDdiag.
CH-2 Timer Error	An error occurred with timer 2.
CMOS Battery State Low	CMOS RAM is powered by a battery. The battery power is low. Replace the battery.
CMOS Checksum Failure	After CMOS RAM settings are saved, a checksum is generated. This message appears if the previous checksum differs from the current checksum. Run AMIBIOS Setup.
CMOS System Options Not Set	The values stored in CMOS RAM are either corrupt or nonexistent. Run AMIBIOS Setup.
CMOS Display	The video type in CMOS RAM does not match the type

Error Message	Explanation
Type Mismatch	detected by AMIBIOS. Run AMIBIOS Setup.
CMOS Memory Size Mismatch	The amount of memory on the motherboard is different than the amount in CMOS RAM. Run AMIBIOS Setup.
CMOS Time & Date Not Set	Run STANDARD CMOS SETUP to set the date and time in CMOS RAM.
D: Drive Error	No response from hard disk drive D:. Drive D: may be missing. If installed, run the Hard Disk Utility. Also, check the D: hard disk type in STANDARD CMOS SETUP to make sure that the hard disk drive type is correct.
D: drive failure	No response from hard disk drive D:. Replace drive D:.
Diskette Boot Failure	The boot disk in floppy drive A: is corrupt. It cannot be used to boot the system. Use another boot disk and follow the screen instructions.
Display Switch Not Proper	Some systems require that a video switch on the motherboard be set to either color or monochrome. Turn the system off, set the switch properly, then power on.
DMA Error	Error in the DMA controller on the motherboard.
DMA #1 Error	Error in the first DMA channel on the motherboard.
DMA #2 Error	An error occurred in the second DMA channel on the motherboard.
FDD Controller Failure	AMIBIOS is not able to communicate with the floppy disk drive controller. Check all appropriate connections after the system is powered down.
HDD Controller Failure	AMIBIOS cannot communicate with the hard disk drive controller. Check all connectors after the system is powered down.
INTR #1 Error	Interrupt channel 1 has failed POST.
INTR #2 Error	Interrupt channel 2 has failed POST.
Invalid Boot Diskette	AMIBIOS can read the diskette in floppy drive A:, but it cannot boot the system with it. Use another boot diskette and follow the screen instructions.
Keyboard Is Locked...Unlock It	The keyboard lock on the system is engaged. The system must be unlocked to continue the boot process.
Keyboard Error	Timing problem in the keyboard. Set <i>Keyboard</i> in STANDARD CMOS SETUP to <i>Not Installed</i> , which skips the keyboard POST routines.
KB/Interface Error	Error in the keyboard connector on the motherboard.
No ROM BASIC	Cannot find a proper bootable sector on either drive A: or hard disk drive C:. ROM Basic (INT 18h) does not run. AMIBIOS cannot find ROM Basic.
Off Board Parity	Parity error in adapter card memory. The format is:

Error Message	Explanation
Error	OFF BOARD PARITY ERROR ADDR (HEX) = (XXXX) XXXX is the hex address where the error occurred. Run AMIDdiag.
On Board Parity Error	Parity error in motherboard memory. The format is: ON BOARD PARITY ERROR ADDR (HEX) = (XXXX) XXXX is the hex address where the error occurred. Run AMIDdiag.
Parity Error ????	Parity error in system memory at an unknown address. Run AMIDdiag.

NMI Messages

NMI Message	Explanation
Memory Parity Error at xxxxx	Memory failed. If the memory location is known, it is displayed as xxxxx. If not, the message is <i>Memory Parity Error ?????</i> .
I/O Card Parity Error at xxxxx	An adapter card failed. If the address is known, it is displayed as xxxxx. If not, the message is <i>I/O Card Parity Error ?????</i> .
DMA Bus Time-out	A device drove the bus signal for more than 7.8 μ seconds.

BIOS Configuration Summary Screen

AMIBIOS System Configuration (C) Copyright 1985-1991 American Megatrends Inc.,			
Main Processor	: 486DX	Base Memory Size	: 640 KB
Numeric Processor	: Present	Ext. Memory Size	: 7808 KB
Floppy Drive A:	: 1.2 MB 5 $\frac{1}{4}$	Hard Disk C: Type	: 44
Floppy Drive B:	: 1.44 MB 5 $\frac{1}{4}$	Hard Disk D: Type	: None
Display Type:	: VGA or EGA	Serial Port(s)	: 3F8
AMIBIOS Date:	: 12/12/91	Parallel Port(s)	: 378

64KB CACHE MEMORY
50 MHz CPU Clock

POST Memory Test

Normally, the only visible POST routine is the memory test. The information that appears when the system is powered on is shown below.

```
AMIBIOS (C) 1992 American Megatrends Inc.,  
  
BIOS Release 50020692  
  
xxxxx KB OK  
  
Press <DEL> if you want to run SETUP  
  
  
  
(C) American Megatrends Inc.,  
xx-xxxx-xxxxxx-xxxxxxxx-xxxxxx-xxxx-x
```

A BIOS Identification String appears in the left bottom corner of the screen, below the copyright message. Press <Ins> during system boot to display two additional BIOS Identification Strings. These strings contain the AMIBIOS options. If a problem occurs:

Step	Action
1	Enable the <i>Wait for <F1> If any Error</i> in ADVANCED CMOS SETUP option before using this method to freeze the screen.
2	When a problem occurs, freeze the screen by powering on the system and holding a key down on the keyboard.
3	Copy the AMIBIOS ID Strings on a sheet of paper before calling American Megatrends technical support at 404-246-8600.
4	Press <F1> to continue the boot process.
5	Hit if you want to run SETUP is displayed. Press to access AMIBIOS Setup.

Chapter 4

AMIBIOS

Keyboard Speed Switching

You can increase processor speeds at any time by pressing <Ctrl> <Alt> <+>. Processor speed can be decreased by pressing <Ctrl> <Alt> <->.

Of course, the OEM can modify these keystroke combinations through AMIBCP. The above settings are the default settings.

AMIBIOS Setup

AMIBIOS Setup is divided into three parts:

- STANDARD CMOS SETUP,
 - ADVANCED CMOS SETUP, and
 - ADVANCED CHIPSET SETUP.
-

STANDARD CMOS SETUP

AMIBIOS STANDARD CMOS SETUP, discussed in Section 1 beginning on page 45, configures system components such as floppy drives, hard disk drives, monitor type, and keyboard.

ADVANCED CMOS SETUP

The ADVANCED CMOS SETUP, discussed in Section 3 beginning on page 50, configures the system password, keyboard typematic rate, boot sequence and speed, and enables system performance features, such as Fast Gate A20 support.

ADVANCED CHIPSET SETUP

ADVANCED CHIPSET SETUP configures chipset-specific options and is discussed in Section 4, beginning on page 54.

Section 1

Running AMIBIOS Setup

The system parameters (such as amount of memory, number and type of disk drives, and video display type) are stored in CMOS RAM. When the computer is turned off, a back-up battery provides power to CMOS RAM, which retains these parameters.

Each time the system is powered on, it is configured with these settings, unless CMOS RAM has been corrupted. AMIBIOS Setup resides in ROM BIOS (Read Only Memory Basic Input/Output System) and is available each time the computer is turned on.

If, for some reason, CMOS RAM becomes corrupted, the system is configured with the BIOS Default settings stored in this ROM file. See page 43 for more information on default settings.

Starting AMIBIOS Setup

When POST has completed, the following message appears:

Hit if you want to run SETUP

Press to run AMIBIOS Setup.

AMIBIOS Setup Keys

Keystroke	Action
<Esc>	Returns to previous screen.
→, ←, ↓, ↑	Move the cursor from one option to the next.
<PgUp> and <PgDn>; <Ctrl><PgUp> and <Ctrl><PgDn>	Modify the default setting of the options for the highlighted parameter. If there are fewer than 10 options, <Ctrl> <PgUp> and <Ctrl> <PgDn> operate like <PgUp> and <PgDn>.
<F1>	Displays Help.
<F2>	Change background colors.
<F3>	Change foreground colors.
<F5>	Restores the settings resident when the current AMIBIOS Setup session began. These settings are taken from CMOS RAM if CMOS RAM was uncorrupted at the start of the session. Otherwise, the BIOS Setup default settings are used.
<F6>	Loads all options in ADVANCED CMOS SETUP and ADVANCED CHIPSET SETUP with the BIOS Setup defaults.
<F10>	Saves all changes made to AMIBIOS Setup and returns to DOS.

Note: The default settings for <F5>, <F6>, and <F7> is always *N*. To execute these options, change the *N* to *Y* and press <Enter>.

Main Menu AMIBIOS Setup Options

AMIBIOS Setup Main Menu options are shown below. Each option is explained in detail in this section.

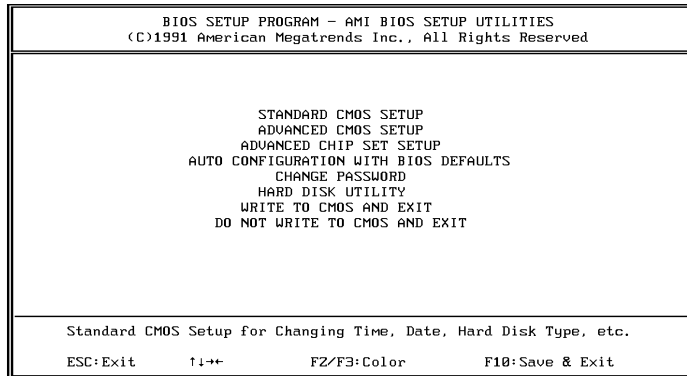

Warning Message

A warning is displayed when STANDARD CMOS SETUP, ADVANCED CMOS SETUP, or ADVANCED CHIPSET SETUP is selected. Press <Enter> to display the next screen.

Auto Configuration With BIOS Defaults

Auto Configuration With BIOS Defaults uses the default system settings for all BIOS options. The BIOS Setup defaults are best-case settings that optimize system performance. If CMOS RAM is corrupted, the BIOS Setup default settings are automatically loaded.

Type *Y* and press <Enter> to use BIOS defaults. The following message appears:

Default values loaded. Press any key to continue.

Write to CMOS and Exit

The options selected and configured in the Standard Setup, ADVANCED CMOS SETUP, ADVANCED CHIPSET SETUP, and the new password (if any) are stored in CMOS RAM when this option is selected. A CMOS RAM checksum is calculated and written to CMOS RAM. Control is then passed to AMIBIOS. The following prompt appears:

Write to CMOS and Exit (Y/N)?

Type *N* and press <Enter> to return to the Main Menu. Type *Y* and press <Enter> to save the system parameters and continue the boot process.

Do Not Write to CMOS RAM and Exit

This option passes control to AMIBIOS without writing any changes to CMOS RAM. Type *N* and press <Enter> to return to the Main Menu. Type *Y* and press <Enter> to continue the boot process without saving system parameters.

STANDARD CMOS SETUP Options, Continued

Hard Disk Drive C:

Hard Disk Drive D:

Move to these fields via the and keys and select the hard disk drive type via <PgUp> and <PgDn> that matches the drive parameters for the hard disk drive in the computer. The hard disk drive manufacturer usually supplies the drive parameters. See the AMIBIOS hard disk drive type table on the following page, which lists the drive parameters for drive types 1 - 46. If the drive parameters do not match any of the drive types in the table, select drive type 47 and enter the drive parameters manually. Type 47 must be used for IDE drives.

Not Installed is used for diskless workstations and SCSI hard disk drives.

Type 47 can be used for both hard disks C: and D:. The parameters for type 47 under Hard Disk C: and Hard Disk D: can be different, permitting two user-definable hard disk drives. The parameters are:

Parameter	Description
Type	The number for a drive with certain identification parameters.
Cylinders	The number of cylinders in the disk drive.
Heads	The number of heads in the disk drive.
Write Precompensation	The size of a sector gets progressively smaller as the track diameter diminishes. Yet each sector must still hold 512 bytes. Write precompensation circuitry on the disk drive compensates for the physical difference in sector size by boosting the write current for sectors on inner tracks. This is the track number where write precompensation begins.
Landing Zone	This number is the cylinder location where the heads normally park when the system is shut down.
Sectors	Number of sectors per track. MFM drives have 17 sectors per track. RLL drives have 26 sectors per track. ESDI drives have 34 sectors per track. SCSI and IDE drives have even more sectors per track.
Capacity	The formatted capacity of the drive is Number of Heads x Number of Cylinders x Number of Sectors per Track x 512 bytes (Bytes per Sector).

STANDARD CMOS SETUP Options, Continued

Hard Disk Drive Types

Type	Cylinders	Heads	Write Precompensation	Landing Zone	Sectors	Capacity
1	306	4	128	305	17	10 MB
2	615	4	300	615	17	20 MB
3	615	6	300	615	17	31 MB
4	940	8	512	940	17	62 MB
5	940	6	512	940	17	47 MB
6	615	4	65535	615	17	20 MB
7	462	8	256	511	17	31 MB
8	733	5	65535	733	17	30 MB
9	900	15	65535	901	17	112 MB
10	820	3	65535	820	17	20 MB
11	855	5	65535	855	17	35 MB
12	855	7	65535	855	17	50 MB
13	306	8	128	319	17	20 MB
14	733	7	65535	733	17	43 MB
16	612	4	0	663	17	20 MB
17	977	5	300	977	17	41 MB
18	977	7	65535	977	17	57 MB
19	1024	7	512	1023	17	60 MB
20	733	5	300	732	17	30 MB
21	733	7	300	732	17	43 MB
22	733	5	300	733	17	30 MB
23	306	4	0	336	17	10 MB
24	925	7	0	925	17	54 MB
25	925	9	65535	925	17	69 MB
26	754	7	754	754	17	44 MB
27	754	11	65535	754	17	69 MB
28	699	7	256	699	17	41 MB
29	823	10	65535	823	17	68 MB
30	918	7	918	918	17	53 MB
31	1024	11	65535	1024	17	94 MB
32	1024	15	65535	1024	17	128 MB
33	1024	5	1024	1024	17	43 MB
34	612	2	128	612	17	10 MB
35	1024	9	65535	1024	17	77 MB
36	1024	8	512	1024	17	68 MB
37	615	8	128	615	17	41 MB
38	987	3	987	987	17	25 MB
39	987	7	987	987	17	57 MB
40	820	6	820	820	17	41 MB
41	977	5	977	977	17	41 MB
42	981	5	981	981	17	41 MB
43	830	7	512	830	17	48 MB
44	830	10	65535	830	17	69 MB
45	917	15	65535	918	17	114 MB
46	1224	15	65535	1223	17	152 MB
47	Enter the drive parameters supplied by the hard disk drive manufacturer.					

STANDARD CMOS SETUP Options, Continued

Floppy Drive A
Floppy Drive B:

Move to these fields via the and keys and select the floppy type via <PgUp> and <PgDn>. The settings are 360 KB 5¼ inch, 1.2 MB 5¼ inch, 720 KB 3½ inch, 1.44 MB 3½ inch, or Not Installed, which configures diskless workstations. AMIBIOS does not generate error messages if Not Installed is selected.

Primary Display

Move to this field via the and keys and select the monitor type via <PgUp> and <PgDn>. The settings are Monochrome, Color 40x25, VGA/PGA/EGA, Color 80x25, or Not Installed, which configures network file servers. AMIBIOS does not generate missing monitor messages if Not Installed is selected.

Keyboard

Move to this field via the and keys and choose a setting via <PgUp> and <PgDn>. The settings are Installed or Not Installed. Use Not Installed in a keyboardless system such as a file server. AMIBIOS does not generate error message for a missing keyboard if Not Installed is selected.

Section 3

ADVANCED CMOS SETUP

ADVANCED CMOS SETUP in AMIBIOS Setup for the Super Voyager LC motherboard is shown below. Use the and keys to scroll through the options.

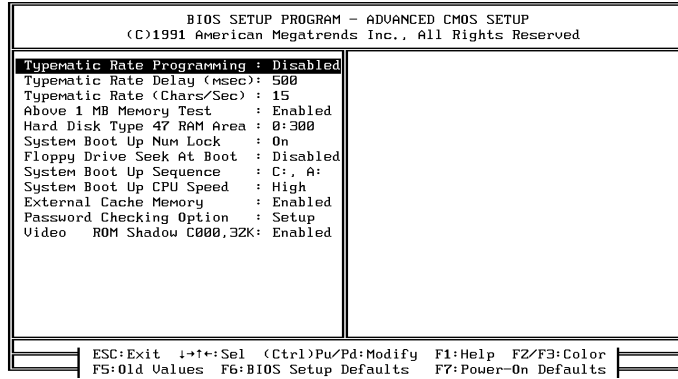

Help Screens

ADVANCED CMOS SETUP has a series of help screens, accessed by pressing <F1>, which displays the settings for an AMIBIOS Setup option when that option is highlighted.

Warning Message

A warning message is displayed each time STANDARD CMOS SETUP, ADVANCED CMOS SETUP, or ADVANCED CHIPSET SETUP is selected. Press any key to continue.

ADVANCED CMOS SETUP Options

Typematic Rate Programming

Typematic Rate Programming

Typematic Rate

Typematic Rate Delay

Typematic Programming enables or disables the following two options. Typematic Rate Delay (*250, 500, 750 or 1,000 milliseconds*) and Typematic Rate (*6, 8, 10, 12, 14, 15, 24, or 30 characters per second*) control the speed at which a keystroke is repeated. A character is displayed when a key is pressed and held down. After a period of time (the Typematic Rate Delay), it repeats at the Typematic Rate.

Above 1 MB Memory Test

When enabled, the POST memory routines run on memory above 1 MB. If disabled, only the first 1 MB is tested. The settings are Enabled or Disabled.

Hard Disk Type 47 RAM Area

You can specify a user-definable hard disk type for drive C: and/or D:. The drive parameters are entered in STANDARD CMOS SETUP (see page 47). This option specifies the type 47 data storage area: *0:300h* in low system RAM or in the *top 1 KB* of applications memory, starting at address 639K or 511K, depending on how much base memory is in the system. Type 47 data is stored in shadow RAM if shadowing is enabled. The following illustrates type 47 data storage.

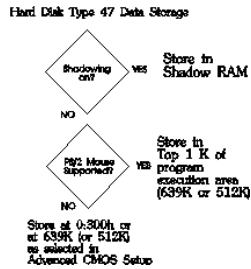

ADVANCED CMOS SETUP Options, Continued

System Boot Up Num Lock

This option turns off Num Lock when the system is powered on so you can use the arrow keys on both the numeric keypad and the keyboard. The settings are *On* or *Off*. The defaults are *On*.

Floppy Drive Seek At Boot

When enabled, a Seek command is performed on drive A: at system boot. The settings are *Enabled* or *Disabled*. The defaults are *Disabled*.

System Boot Up Sequence

This option sets the sequence of drives that AMIBIOS looks for at system boot. The settings are *C:,A:* or *A:,C:*. The BIOS Setup default is *C:,A:*. The Power-On default is *A:,C:*.

System Boot Up CPU Speed

This option sets the system speed when the system boots. The settings are *High* or *Low*. The BIOS Setup and Power-On default is *High*.

External Cache Memory

This option enables cache memory external to the processor if enabled. The settings are *Enabled* (the default) or *Disabled*.

ADVANCED CMOS SETUP Options, Continued

Password Checking Option

This option can enable password checking every time the system boots or AMIBIOS Setup is run. The settings are *Setup* - a password prompt appears when AMIBIOS Setup is run (The default) or *Always* (a password prompt appears every time the system is turned on). See page 57 for more information.

Video ROM Shadow C000,32K

When enabled, this option copies the 32 KB of Video ROM at C000h – C7FFh to RAM. The settings are *Enabled* (the default) or *Disabled*.

C000 Shadow RAM Cacheable

The settings are *Enabled* or *Disabled*. If enabled, the 32 KB shadowed video memory can also be cached in the 80486 internal cache memory, which may result in bad video data because the internal cache cannot be write-protected and may be corrupted by an external program. Before enabling this option, you must be reasonably certain that the applications running on this system will not write to the C000:0 – 07FFFh area.

Section 4

ADVANCED CHIPSET SETUP

The Super Voyager LC BIOS ADVANCED CHIPSET SETUP screen is shown below. Use the and keys to scroll through the options.

BIOS SETUP PROGRAM - ADVANCED CHIPSET SETUP (C)1991 American Megatrends Inc., All Rights Reserved	
8-bit AT Cycle Wait State : 4 US	
16-bit AT Cycle Wait State : 1 US	
Cache Write Back : Enabled	
C000 Shadow RAM Cacheable : Disabled	
Non-Cacheable Block-1 : Disabled	
Non-Cacheable Block-1 Size : 1MB	
Non-Cacheable Block-1 Base : 512KB	
ESC:Exit ←+→:Sel (Ctrl)Pu/Pd:Modify F1:Help F2/F3:Color	
F5:Old Values F6:BIOS Setup Defaults F7:Power-On Defaults	

Help Screens

As with all AMIBIOS Setup screens, each ADVANCED CHIPSET SETUP option has context-sensitive Help information. Press <F1> when the option is highlighted to display the Help screen for that option.

Warning Screen

A warning screen appears when ADVANCED CHIPSET SETUP is selected. Press any key to continue.

ADVANCED CHIPSET SETUP Options

8-bit AT Cycle Wait State

This option sets the number of wait states inserted before 8-bit AT cycle operations. The settings are 4 WS (the default) or 5 WS.

16-bit AT Cycle Wait State

This option sets the number of wait states inserted before 16-bit AT cycle operations. The settings are 1 WS (the default) or 2 WS.

Cache Write Back

The settings are Enabled or Disabled (the default). If enabled, a write-back caching algorithm is used. If disabled, a write-through caching algorithm is used.

Non-Cacheable Block-1

This option selects the allocation method used for Non-Cacheable Block 1. The settings are DRAM (local DRAM is used - the default) or ATBus (DRAM is disabled and the AT bus is used).

Non-Cacheable Block-1 Size

If the Non-Cacheable Block Base Address setting is 512 KB, the block size settings are 128 KB or Disabled (the default). If the **Non-Cacheable Block-1 Base Address** setting is any other value, the settings are 64KB, 128KB, 256KB, 512KB, 1MB, 2MB, 4MB, or Disabled.

Non-Cacheable Block-1 Base

The Non-Cacheable Block-1 Base Address can change in increments equal to the setting of **Non-Cacheable Block-1 Size**. If below 1 MB, the Non-Cacheable Block-1 Base Address can only be 512KB (the default).

Section 5

AMIBIOS Password Support

AMIBIOS Setup has an optional password feature. The system can be configured so that all users must enter a password every time the system boots or when Setup is executed.

Setting a Password

The password check option is enabled in ADVANCED CMOS SETUP (see page 53) by choosing either Always or Setup. The password is stored in CMOS RAM.

The following prompt appears when the system boots.

Enter CURRENT Password:

Enter a 1 – 6 character password. Make sure you write it down. If you forget it, you must drain CMOS RAM and totally reconfigure the system.

If You Do Not Want to Use a Password

Just press <Enter> when the password prompt appears .

Changing a Password

Select the *Change Password* option from the AMIBIOS Setup Main Menu.

Enter the password and press <Enter>. The screen does not display the characters entered. After the new password is entered, retype the new password as prompted and press <Enter>.

If the password confirmation is incorrect, an error message appears. If the new password is entered without error, press <Esc> to return to the AMIBIOS Setup MAin Menu. The password is stored in CMOS RAM after AMIBIOS Setup completes. The next time the system boots, you are prompted for the password if the password function is present and has been enabled.

Password Options Control Prompt

When and if the prompt appears depends on the Password Option settings in ADVANCED CMOS SETUP. If *Always* was set in ADVANCED CMOS SETUP, the prompt appears when the system is powered on. If *Setup* was set, the prompt appears when AMIBIOS Setup is executed.

Remember the Password

Keep a record of the new password when the password is changed. If you forget the password and password protection is enabled, the only way to boot the system is to disable CMOS RAM by removing the shorting block from J33 to drain CMOS RAM power, replacing it, rebooting, and reconfiguring the system.

Section 6

Hard Disk Utility

AMIBIOS includes three hard disk utilities:

Utility	Purpose	Turn to
Hard Disk Format	Performs a low level format of the hard drive(s). Read the system or hard disk drive documentation to find out if the hard disk has been preformatted.	Page 61
Auto Interleave	Determines the optimum interleave factor and then performs a low level format of the hard disk drive.	Page 63
Media Analysis	Analyzes each hard disk drive track to determine whether it is usable. The track is labeled bad if unusable.	Page 55

The hard disk utility error messages are described on page 65.

These routines work on drives that use the MFM, RLL, ARLL, or ESDI data recording techniques. They do not work on IDE or SCSI Disk Drives.

Warning

AMIBIOS Hard Disk Utilities destroy all hard disk data. Back up the data on the hard disk before running this utility.

When to Use AMIBIOS Hard Disk Utilities

When	Conditions	Run...
Installing a new hard disk.	The hard disk drive manufacturer provided a list of bad tracks, the system documentation includes the optimum interleave factor, and the drive is preformatted .	None
Installing a new hard disk.	You do not have a list of bad tracks.	Media Analysis
Installing a new hard disk.	You do not know the optimum interleave factor.	Auto Interleave
Installing a new hard disk.	The drive is not formatted.	Hard Disk Format
Installing a used hard disk drive.	N/A	All Hard Disk Utilities

When Hard Disk Diagnostics is selected, the following screen appears.

AMIBIOS SETUP PROGRAM -- CMOS SETUP PROGRAME (C) 2001 American Megatrends Inc .. All Rights Reserved						
	Cyln	Head	Wpcom	LZone	Sect	Size (in MB)
Hard Disk C: Type : 40	820	6	820	820	17	41
Hard Disk D: Type : Not Installed						
Hard Disk Type can be chanded form the STANDARD SETUP option in main menu						
Hard Disk Format Auto Interleave Media Analysis						
┌───────────┴───┐ ESC:Exit ↑→↓← :Sel FZ:Color ┌───────────┴───┐						

Select an option and press <Enter>.

Hard Disk Format Utility

Warning

The Hard Disk Format utility destroys all hard disk data. Back up the data on the hard disk before running this utility.

This routine does not work on IDE or SCSI drives. Use Hard Disk Format to integrate a new hard disk to the system, or to reformat a used hard disk which has developed bad tracks as a result of aging or poor handling. Select Media Analysis to find bad tracks. The following screen appears when Hard Disk Format is selected.

AMIBOIS SETUP PROGRAM -- CMOS SETUP PROGRAM																		
(C) 2001 American Megatrends Inc .. All Rights Reserved																		
	Cyln	Head	Wpcom	LZone	Sect	Size (in MB)												
Hard Disk C: Type :	40																	
	820	6	820	820	17	41												
Hard Disk D: Type :	Not Installed																	
<table border="1"><thead><tr><th colspan="2">Hard Disk Format</th></tr></thead><tbody><tr><td>Disk Drive (C / D)</td><td>? C</td></tr><tr><td>Disk Drive Type</td><td>? 40</td></tr><tr><td>Interleave (1 - 16)</td><td>? 3</td></tr><tr><td>Mark Bad Tracks (Y / N)</td><td>? N</td></tr><tr><td>Proceed (Y / N)</td><td>? N</td></tr></tbody></table>							Hard Disk Format		Disk Drive (C / D)	? C	Disk Drive Type	? 40	Interleave (1 - 16)	? 3	Mark Bad Tracks (Y / N)	? N	Proceed (Y / N)	? N
Hard Disk Format																		
Disk Drive (C / D)	? C																	
Disk Drive Type	? 40																	
Interleave (1 - 16)	? 3																	
Mark Bad Tracks (Y / N)	? N																	
Proceed (Y / N)	? N																	
ESC:Exit ↑→←↓:Sel																		

Hard Disk Format Screen

Answer the questions on the screen. The first two questions are already completed if only one hard disk drive was selected in STANDARD CMOS SETUP and the cursor is on *Interleave*. The Disk Drive Type is read from CMOS RAM. The interleave factor can be selected manually or determined by the Auto Interleave routine.

The hard disk drive manufacturer usually provides a list of bad tracks. Enter these tracks. They are then labeled as bad to prevent data from being stored on them. The following screen is displayed after entering *Y* in Mark Bad Tracks, pressing <Enter>, and selecting add, delete, revise, or clear from the Bad Track Edit Menu.

AMIBOIS SETUP PROGRAM -- CMOS SETUP PROGRAME (C) 2001 American Megatrends Inc .. All Rights Reserved						
	CylIn	Head	Wpcom	LZone	Sect	Size (in MB)
Hard Disk C: Type :	40	820	6	820	820	17 41
Hard Disk D: Type :	Not Installed					
Hard Disk Format		Bad Track Edit Menu		Bad Track # 0		
Disk Drive (C / D) ?	C	Add an Entry	No. CylIn. Head			
Disk Drive Type ?	40	Revise an Entry				
Interleave (1 - 16) ?	3	Delete an Entry				
Mark Bad Tracks (Y / N) ?		Clear Bad Trk List				
Proceed (Y / N) ?		Enter Cylinder # : 0				
		Enter Head # :				
ESC:Exit ↑→↓←:Sel						

Type *Y* and press <Enter>. A warning screen appears. Press any key to continue .

Warning Data on the hard drive will be irrevocably lost.
--

Auto Interleave Utility

Warning

The Auto Interleave utility destroys hard disk data. Back up the data on the hard disk before running this utility.

The Auto Interleave utility calculates the optimum interleave factor through trial and error by measuring the transfer rate for four different interleave values. To determine the best interleave factor, the system formats a portion of the hard disk for each transfer rate calculated. The cylinders, heads and sectors formatted for each value is displayed in the activity box. It does not work on IDE or SCSI drives.

Select Auto Interleave on the main Hard Disk Utility Screen and press <Enter>. The following appears .

AMBOIS SETUP PROGRAM -- CMOS SETUP PROGRAM						
(C) 2001 American Megatrends Inc .. All Rights Reserved						
	Cyl/n	Head	Wpcom	LZone	Sect	Size (in MB)
Hard Disk C: Type :	40	820	6	820	820	17 41
Hard Disk D: Type :	Not Installed					
Auto Interleave		Bad Track Edit Menu		Bad Track # 0		
Disk Drive (C / D) ? C	Add an Entry		No. Cyl/n. Head			
Disk Drive Type ? 40	Revise an Entry					
Mark Bad Tracks (Y / N) ?	Delete an Entry					
Proceed (Y / N) ?	Clear Bad Trk List					
		Enter Cylinder # : 0				
		Enter Head # :				
ESC:Exit ↑→↓←:Sel						

The cursor is on *Mark Bad Tracks*. The default is *N*. To mark additional bad tracks, type *Y* and press <Enter>. After selecting options from the Bad Tracks Edit Menu, press <Esc>. Type *Y* and press <Enter> to proceed with the Auto Interleave process. A warning screen appears. Press <Enter> to return to the main Hard Disk Utility screen. To proceed, type *Y* and press <Enter>.

Media Analysis Utility

The Media Analysis utility performs a series of tests to locate bad or damaged tracks on the hard disk as a result of aging or poor handling. This utility locates all bad tracks and lists them in the Bad Track List Box. Since this test writes to all cylinders and heads on the hard disk to verify any bad tracks, the test requires several minutes to complete. For best results, run this test in its entirety. Media Analysis does not work on IDE or SCSI drives.

Select Media Analysis from the main Hard Disk Utility Menu and press <Enter>. The following screen appears.

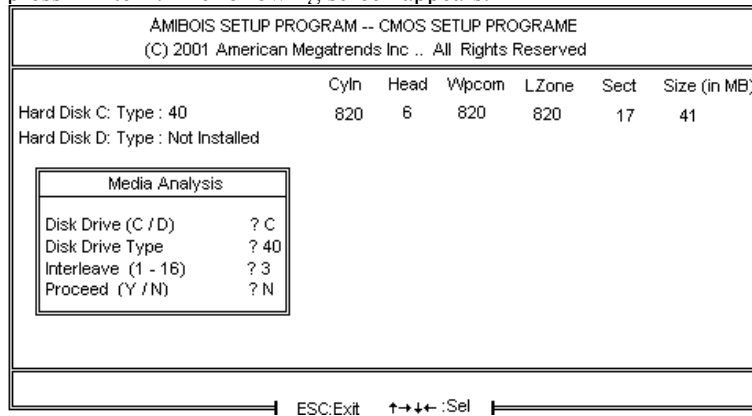

Media Analysis

Screen

The cursor is on Proceed. The warning screen appears. Press <Enter> to stop. The main Hard Disk Utility screen appears. Type Y and press <Enter> to perform the hard disk drive analysis.

Hard Disk Utility Error Messages

Initialization Errors

Message	Explanation
No Hard Disk Installed	There is no hard disk drive in the system but Hard Disk Utility was selected.
FATAL ERROR Bad Hard Disk	No response from the hard disk, or the hard disk is not repairable. Check all cable and power connections to the hard disk.
Hard Disk Controller Failure	Error response from the reset command sent to the hard disk controller. The controller may not be seated properly in the BUS slot.
C: (D:) Hard Disk Failure	The hard disk drive (C: or D:) is not responding to commands. Check power and cable connections to the hard disk.

Hard Disk Utility Error Messages, Continued

Operation Errors

Message	Explanation
Address Mark Not Found	The address mark (initial address) on the hard disk could not be found.
Attachment Failed to Respond	No response has been received from the hard disk drive.
Bad ECC on Disk Read	When the hard disk drive utility writes to the disk, it also calculates an ECC (Error Correction Code) value for the data being written. This ECC value is written to the drive and then read back. The value read back is different from the one calculated.
Bad Sector Flag Detected	An operation was performed on a sector that has been flagged as bad.
Controller Has Failed	A diagnostic command was issued to the controller failed.
Drive Not Ready	An operation on the hard disk drive has timed out. The hard disk drive utility has waited beyond a preset specified time limit.
Drive Parameter Activity Failed	A reset command was sent to the controller followed by drive parameters. Using these parameters, the controller did not get a response from the hard disk. Make sure the drive type is correct.
ECC Corrected Data Error	The ECC value (explained above) read from the disk is not the same value which was written to the disk. The data is not correct. An attempt was made to correct the data, but the ECC value is not corrected.
Requested Sector Not Found	The requested sector could not be found.
Reset Failed	The reset command did not properly reset the hard disk.
Seek Operation Failed	A seek command failed. A seek operation is the act of finding a particular sector on the hard disk.
Undefined Error - Command Aborted	An unidentifiable error condition occurred.
Write Fault on Selected Drive	A write fault occurred during the write operation on the hard disk drive.

Appendix A

Upgrading to 256 KB Cache

Parts

To upgrade to 256 KB of cache memory, you will need 28-pin 32 KB x 8 static RAM chips with an access time of 15 or 20 ns:

- If the motherboard has a 33 or 50 MHz processor, use 15 ns SRAM.
 - if the motherboard has a 16, 20, or 25 MHz processor, use 20 ns SRAM.
-

Procedure

Step	Action
1	Move all switches on SW1 to ON.
2	Remove all old SRAM chips from U34, U35, U36, U37, U38, U39, U40, and U41.
3	Place the new 28-pin 32 KB x 8 static RAM chips in U34, U35, U36, U37, U38, U39, U40, and U41. Make sure that the pins are straight and that all pins are inserted in the receptacles.
4	Turn the system on. The Boot Screen should display 256 KB of cache memory. If 256 KB does not display, check for bent pins on the new SRAM chips.

SRAM Locations

The figures on the following page shows the location of SRAM chips and SW1, discussed above.

Cache Diagram

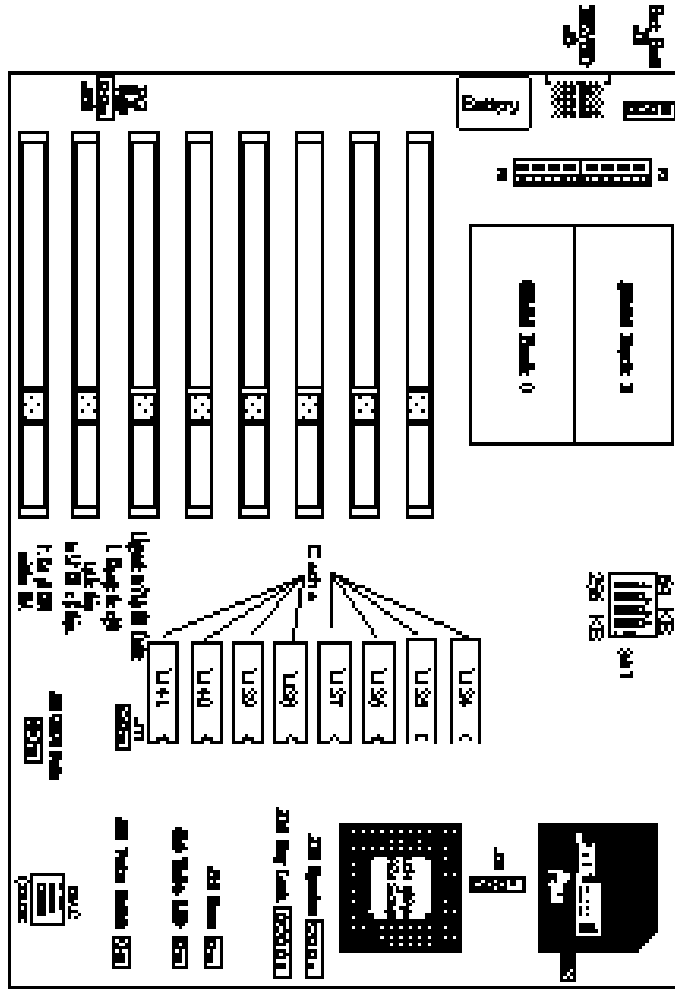

Appendix B

Heat Dissipation

The 50 MHz 80486DX and 66 MHz 80486DX2 are very high performance CPUs that can rival the performance of any currently available CPU, including RISC processors. However, there is an undesirable side effect to the high performance — the heat generated by high power consumption.

These CPUs can dissipate up to 5 watts of power. Since this power is concentrated in a small area, it is necessary to remove the heat generated by this power consumption. For this reason we have supplied a heat sink with all American Megatrends motherboards and CPU Cards that have a 50 MHz 80486DX or 66 MHz 80486DX2 CPU.

Since American Megatrends manufactures only the motherboard and CPU Card system components, it has no control over operating factors such as air flow and ambient temperature inside the computer case. The system integrator must make sure that the 50 MHz 80486DX or 66 MHz 80486DX2 CPU always operates within a safe operating temperature range.

Test Procedure to Assure Proper Operating Temperatures:

1. Install the American Megatrends motherboard or CPU card in a fully loaded system.
 2. Install a temperature sensor (such as a thermocouple) so that the surface of the heat sink can be measured without opening the case.
 3. Turn on the system and run a diagnostics utility program such as AMIDiag for at least one hour.
-

Expected Results

If the temperature on the surface of the heat sink is 75 degrees centigrade or below, there will be no problem with the operation of the computer.

Identifying a Problem

If the temperature exceeds 75 degrees centigrade, the system integrator must take the necessary measures to ensure that the CPU does not overheat.

Potential Solutions

- Install a fan to increase the air flow over the CPU. Some power supplies may have larger or more powerful fans.
 - Install a different heat sink with a greater surface area.
 - Different case styles may have better ventilation allowing for more air-flow over the CPU.
-

Appendix C

Using QEMM®

Using QEMM Version 5.0 and higher with the Series 61 Motherboard

This discussion applies to the Series 61 motherboard running at any frequency.

When QEMM from QuarterDeck Office Systems is used with no command line options, it checks the chipset on the motherboard to determine if it is a C&T 386 or C&T® NEAT® CHIPset.

QEMM incorrectly determines that a C&T CHIPset is installed on the Series 61 motherboard and tries to program I/O registers specific to the C&T CHIPset. This feature was written only for motherboards containing the C&T CHIPset and causes the Series 61 motherboard to reboot.

To prevent QEMM from programming the I/O registers, add:

```
Device = drive:path\QEMM.SYS NOSH
```

to CONFIG.SYS. The **NOSH** parameter does not effect system operation or performance.

Appendix D

Miscellaneous Series 61 BIOS Data

The following information was gathered from the AMIBCP file for the Series 61 AMIBIOS.

BIOS Setup Options

Halt on error during POST:	No
Initialize CMOS in Every Boot:	No
Keyboard Controller Output Pin 23,24 Blocked:	Yes
Mouse Support in BIOS/Keyboard Controller:	No
In Case of POST Error, Wait for <F1> Key:	Yes
Display Floppy Error During POST:	Yes
Display Video Error During POST:	Yes
Display Keyboard Error During POST:	Yes
CMOS SETUP Option:	Present
ADVANCED CMOS SETUP Option:	Present
ADVANCED CHIPSET SETUP Option:	Present
POWER MANAGEMENT SETUP Option:	Absent
PERIPHERAL SETUP Option:	Absent
BIOS Setup Def. Auto Configuration Option:	Present
Power-On Def. Auto Configuration Option:	Absent
Change Password Option:	Present
Hard Disk Utility Option:	Present

BIOS Features

BIOS Date:	12/12/91
BIOS Name:	AMI/S61
Processor:	80486
ID String 1:	40-0100-004661-00101111-121291-AMI/S61
ID String 2:	000-0-00E8-02-FD-00E8-00-FD-000
ID String 3:	000-0-0000-00-00-0000-00-00-00-2
Major Version Number:	01
Minor Version Number:	00
Reference Number:	00 4661

Miscellaneous BIOS Facts, Continued

Advanced BIOS Features

Clock Switching through a special port:

High/On value: I/O port 00E8h, Data = 02, Mask = FD

Low/Off value: I/O port 00E8h, Data = 00, Mask = FD

Index

- 16-bit DMA Active Clock 54
- 8-bit AT Cycle Wait State 54
- 8042 - Gate A20 Failure 32
- Above 1 MB Memory Test 50
- Adapter Card
 - 16-Bit Card Pinout 28
 - 8-Bit Pinout 29
- Auto Interleave Utility 57, 61
- Base 64 KB Memory Failure 32
- BBS vii
- BIOS
 - Advanced Features 72
 - Beep Codes 32
 - Error Reporting 31
 - Fatal Errors 32
 - Features 71
 - Hard Disk Utilities 57
 - Miscellaneous facts 71
 - Non-Fatal Error Messages 33
 - Password Check 52
 - Password Support 55
 - POST (Power-On Self Test) 31
 - Setup options 71
- BIOS Setup 37
- Board Layout 8
- Built-in Battery 3
- C: Drive Error 33
- C000 Shadow RAM Cacheable 52
- Cables 23
- Cache Write Back 54
- CMOS Display Type Mismatch 33
- CMOS Shutdown Register Read/Write Error 32
- CMOS System Options Not Set 33
- Configuring System 30
- Connectors
 - J3 Keyboard Connector 22
 - PS2 Power Supply 20
 - PS3 Power Supply 20
- Coprocessors
 - Test 17
- EGA Adapters 10
- External Battery Connector 27
- External Cache Memory 52
- Fast page access 14
- Floppy Drive 48
- Hard Disk 45
- Hard Disk Format 57

Index, Continued

- Hard Disk utilities 57
 - Error messages 63
 - When to use 58
- Hard Drive 45
- Heat Dissipation 67
- Heat Sink for 50 MHz CPUs 2
- Hidden refresh 14
- I/O Port 80h 31
- Installation Steps 9
- Installing Adapter Cards 28, 29
- Installing the Motherboard 18
- Intel Upgradable Processor 17
- Interleave factor 61
- Interleaved memory 14
- J1 External Battery Connector 27
- J12 Select Processor Type 12
- J15 Speaker Cable 24
- J16 26
- J16 Turbo LED 26
- J17 Clock Select 12
- J18 Keyboard Lock Connector 25
- J21 Turbo Switch 26
- J22 Reset Button Connector 24
- J23 PowerGood Select 12
- J33 CMOS RAM Drain 12, 13
- Jumpers 10
- Keyboard
 - J3 Connector 22
- Keyboard Lock Connector 25
- Layout 8
- Manufacturing Test Port 31
- Mark Bad Tracks 61
- Media Analysis Utility 57, 62
- Memory
 - Fast page access 14
 - Hidden refresh 14
 - Installation 13
 - Interleaved 14
- Monitor 48
- Motherboard Layout 8
- Non-Cacheable Block-1 54
- Non-Cacheable Block-1 Base 54
- Non-Cacheable Block-1 Size 54
- Num Lock 51
- P2 and P3 21
- Password
 - Forgetting the 13
 - Removing 13

Index, Continued

- POST Memory Test 36
- Power Supply 20, 21
 - Cutting keys 20
- Processor error 32
- QEMM 69
- Reset Button Connector 24
- SCSI 59
- Setup 37
 - Above 1 MB Memory Test 50
 - Auto Configuration 41
 - Auto Configuration, BIOS Defaults 41
 - Exiting 42
 - Floppy Drive Seek At Boot 51
 - Floppy Drives 48
 - Hard Disk Configuration 45
 - Hard Disk Parameter Table 46
 - Key Usage 40
 - Keyboard 48
 - Monitor 48
 - Options, Main Menu 41
 - Password Check 52
 - ROM Shadow 52
 - Running Setup 39
 - STANDARD CMOS SETUP 43
 - System Boot Up CPU Speed 52
 - System Boot Up Num Lock 51
 - System Boot Up Sequence 52
 - Typematic Rate 50
 - Typematic Rate and Delay 50
 - Typematic Rate Delay and Typematic Rate 50
 - Warning Message 41
 - Warning Screen 49
- SIMMs 13
 - Installing 15
 - Part numbers 15
- Speaker Cable Connector 24
- Specifications 2
- SRAM 65
- SRAM Type 3
- SW1 10
- SW2 Diagnostics and Color 10
- Switch and Jumper Options 10
- Switches
 - SW1 10
- Technical Support 7
- Testing System 30
- Testing the Motherboard 30

Index, Continued

Turbo LED 26
Turbo Switch 26
U33 17
Unpacking the Motherboard 7
Upgradable Processor 17
VGA adapters 10
Video ROM Shadow C000,32K 52
Warning Message 41
