



**Megaplex II Quad Pentium II[®]
Xeon[™]/ Pentium III Xeon PCI ISA
System Guide**

MAN-782
6/15/00

Table of Contents

1	Hardware Installation	1
	Features	1
	Megaplex II Dimensions	4
	Installation Steps	7
	Avoid Static Electricity	7
	Step 1 Unpack the Boards	8
	Step 2 Configure Motherboard.....	9
	Step 3 Install Memory	14
	Step 4 Install Motherboard.....	18
	Step 5 Connect Power Supply	20
	Step 6 Attach Connectors.....	22
	Step 7 Test and Configure.....	35
2	AMIBIOS® Setup.....	37
	AMIBIOS Setup Menu	38
	Section 1 Standard Setup.....	39
	Section 2 Advanced CMOS Setup.....	44
	Section 3 Power Management Setup.....	49
	Section 4 PCI/PnP Setup	53
	Section 5 Peripheral Setup	57
	Section 6 Other Setup Options	60
	Auto-Detect Hard Disks	60
	AMIBIOS Password Support.....	60
	Change User Password.....	61
	Change Supervisor Password.....	61
	Change Language Settings.....	61
	Auto Configuration with Optimal Settings	62
	Auto Configuration with FailSafe Settings	62
	Save Settings and Exit.....	62
	Exit Without Saving.....	62
3	Programming the Flash ROM	63
	Bootblock Code Checkpoint Codes	67
A	Specifications	69
	Engineering Specifications.....	69
	Index	71

Preface

To the OEM Thank you for purchasing the high performance American Megatrends Megaplex II Quad Pentium II Xeon /Pentium III Xeon™ PCI ISA System. This product is a state-of-the-art set of a memory card and a motherboard that includes the famous AMIBIOS.

This manual was written for the OEM to assist in the proper installation and operation of this product. This manual describes the specifications and features of the Quad Pentium II Xeon /Pentium III Xeon system. It explains how to assemble a system based on the Quad Pentium II Xeon /Pentium III Xeon system and how to use the AMIBIOS that is specifically designed for this system. In addition, it describes AMI Server Manager Version 1.00, which is used to manage several servers simultaneously from one location.

This manual is not meant to be read by the computer owner who purchases a computer with this system. It is assumed that you, the computer manufacturer, will use this manual as a sourcebook of information, and that part of this manual will be included in the computer owner's manual.

Limited Warranty The buyer agrees if this product proves to be defective, that American Megatrends is only obligated to repair or replace this product at American Megatrends' discretion according to the terms and conditions of the warranty registration card that accompanies this product. American Megatrends shall not be liable in tort or contract for any loss or damage, direct, incidental or consequential resulting from the use of this product. Please see the Warranty Registration Card shipped with this product for full warranty details.

Limitations of Liability American Megatrends, Inc. shall in no event be held liable for any loss, expenses, or damages of any kind whatsoever, whether direct, indirect, incidental, or consequential (whether arising from the design or use of this product or the support materials provided with the product). No action or proceeding against American Megatrends may be commenced more than two years after the delivery of product to Licensee of Licensed Software.

Licensee agrees to defend and indemnify American Megatrends from any and all claims, suits, and liabilities (including attorney's fees) arising out of or resulting from any actual or alleged act or omission on the part of Licensee, its authorized third parties, employees, or agents, in connection with the distribution of Licensed Software to end-users, including, without limitation, claims, suits, and liability for bodily or other injuries to end-users resulting from use of Licensee's product not caused solely by faults in Licensed Software as provided by American Megatrends to Licensee.

Cont'd

Preface, Continued

Technical Support AMI provides technical support only for AMI products purchased directly from AMI or from an AMI-authorized reseller.

If...	Then...
You purchased this product from AMI or from a certified AMI reseller,	Call AMI technical support at 770-246-8600. Please be prepared to specify the serial number of the product.
This AMI product was installed as part of a system manufactured by a company other than AMI or you purchased an AMI product from an unauthorized reseller,	Call the technical support department of the computer manufacturer or the unauthorized reseller. AMI does not provide direct technical support in this case.

Web Site We invite you to access our web site at:

<http://www.ami.com>

Packing List You should have received the following:

- a Series 782 motherboard,
 - three CPU termination cards,
 - a Series 777 memory card,
 - four retention units, which include four base mechanisms, four top covers, eight ears, four pegs, and sixteen screws with nuts,
 - four heatsinks for Pentium II Xeon /Pentium III Xeon CPUs with sixteen mounting screws,
 - AMI Supervisor CD, with ATI Rage IIC VGA Drivers,
 - the *Megaplex II Quad Pentium II Xeon /Pentium III Xeon PCI ISA System Guide* and,
 - the warranty card.
-

Static Electricity The Megaplex II Quad Pentium II Xeon /Pentium III Xeon motherboard and memory card can easily be damaged by static electricity. Make sure you take appropriate precautions against static electric discharge:

- wear a properly-grounded wristband while handling the Megaplex II system or any other electrical component;
 - touch a grounded anti-static surface or a grounded metal fixture before handling the Megaplex II system,
 - handle system components by the mounting bracket.
-

Cont'd

Batteries

Caution

Make sure you dispose of used batteries according to the battery manufacturer's instructions. Improper use of batteries can cause an explosion. Make sure you follow the battery manufacturer's instructions about using the battery. Replace used batteries with the same type of battery or an equivalent recommended by the battery manufacturer.

Attention

Il y a danger d'explosion s'il y a remplacement de la batterie. Remplacer uniquement avec une batterie du même type ou d'un équivalent recommandé par la constructeur. Mettre au rebut les batteries usagées conformément aux instructions du fabricant.

Disclaimer

This manual describes the installation and operation of the American Megatrends Megaplex II Quad Pentium II Xeon /Pentium III Xeon PCI ISA system. Although efforts have been made to assure the accuracy of the information contained here, American Megatrends expressly disclaims liability for any error in this information, and for damages, whether direct, indirect, special, exemplary, consequential or otherwise, that may result from such error, including but not limited to the loss of profits resulting from the use or misuse of the manual or information contained therein (even if American Megatrends has been advised of the possibility of such damages). Any questions or comments regarding this document or its contents should be addressed to American Megatrends at the address shown on the cover. American Megatrends provides this publication "as is" without warranty of any kind, either expressed or implied, including, but not limited to, the implied warranties of merchantability or fitness for a specific purpose. Some states do not allow disclaimer of express or implied warranties or the limitation or exclusion of liability for indirect, special, exemplary, incidental or consequential damages in certain transactions; therefore, this statement may not apply to you. Also, you may have other rights which vary from jurisdiction to jurisdiction. This publication could include technical inaccuracies or typographical errors. Changes are periodically made to the information herein; these changes will be incorporated in new editions of the publication. American Megatrends may make improvements and/or revisions in the product(s) and/or the program(s) described in this publication at any time.

Requests for technical information about American Megatrends products should be made to your American Megatrends authorized reseller or marketing representative.

1 Hardware Installation

Features

The American Megatrends Megaplex II Quad Pentium II Xeon /Pentium III Xeon ISA PCI system supports one to four Intel® Pentium II Xeon /Pentium III Xeon CPUs operating at 400/450 MHz or higher.

Components The Megaplex II consists of the following components:

- one Series 782 motherboard,
 - three CPU termination cards, and
 - one Series 777 memory card.
-

CPUs The four Pentium II Xeon /Pentium III Xeon CPU sockets are mounted on the Series 782 board.

System Memory The Megaplex II system supports up to 4 GB of system memory. This system supports four-way interleaved memory operation with ABP for maximum performance. The system supports 168-pin buffered EDO DIMMs (FPM is not supported.) The system memory supports ECC (Error Checking and Correction).

Note: DRAM system memory is measured in megabits. For example, a DIMM that is 4 M x 72 has four 256 megabits or 32 MB of memory. See page 15 for more information about DRAM specifications.

Cont'd

Features, Continued

Cache Memory The Megaplex II system supports up to 2 MB of cache memory internal to each Pentium II Xeon /Pentium III Xeon CPU.

ISA Expansion The Megaplex II motherboard includes one ISA expansion slot and can handle full-length ISA adapter cards.

PCI Local Bus The Megaplex II motherboard has seven PCI expansion slots, three 32-bit and four 64-bit. The 32-bit slots are on two peer PCI buses provided by the first PXB (PCI Expander Bridge), while the 64-bit slots are on another independent PCI bus provided by the second PXB. All PCI slots are bus master slots. All PCI expansion slots can handle full-length PCI adapter cards.

Integrated I/O The Megaplex II motherboard provides the following integrated I/O:

- one bidirectional parallel port that operates in Normal, EPP, or ECP mode,
- a VGA connector,
- two serial port connectors with 16550A UARTs,
- one floppy drive controller with support for 360 KB, 720 KB, 1.2 MB, 1.44 MB, and 2.88 MB floppy drives,
- dual channel Ultra DMA IDE ATA/33 support, and
- a standard 2-in-1 connector assembly for PS/2 keyboard and PS/2 mouse.

Cont'd

Features, Continued

Onboard VGA The Megaplex II includes an onboard ATI Rage IIC PCI VGA controller with 2 MB of SGRAM. Video drivers for Windows NT are provided. You can download video drivers for all other operating systems from the ATI web site. Make sure you load the ATI Rage IIC drivers from the diskette provided. Windows 95 auto detection tries to load the ATI Mach 64 drivers, which will not function properly.

Setting a jumper on J17 can disable the onboard ATI Rage IIC PCI VGA controller.

AMIBIOS AMIBIOS includes a PCI BIOS with AMIBIOS® Setup in flash ROM. Features include:

- automatic CPU detection,
 - Plug and Play NVRAM and PCI-PCI bridge support,
 - DMI support,
 - ATAPI support for IDE CD-ROM drives,
 - complete SMI/ACPI support,
 - ability to boot from a CD-ROM drive,
 - flex boot/silent boot support,
 - ZIP drive support,
 - GPNVRAM support,
 - automatically detects IDE drive parameters,
 - supports Enhanced IDE, including four IDE drives,
 - supports ATA IDE mode programming,
 - provides LBA and Block Mode support,
 - provides boot sector virus protection,
 - automatically detects and configures system memory, cache memory, and the CPU type,
 - automatically configures PCI devices, and
 - complies with the Plug and Play Version 1.0A BIOS specification.
-

PCI Bus Speed The Megaplex II system conforms to the PCI Version 2.1 specification. The PCI slots are automatically configured by the AMIBIOS. The PCI slots operate synchronously with the CPU clock at 33 MHz.

Megaplex II Dimensions

Series 782 Board The Series 782 board is 16.5" by 13.8".

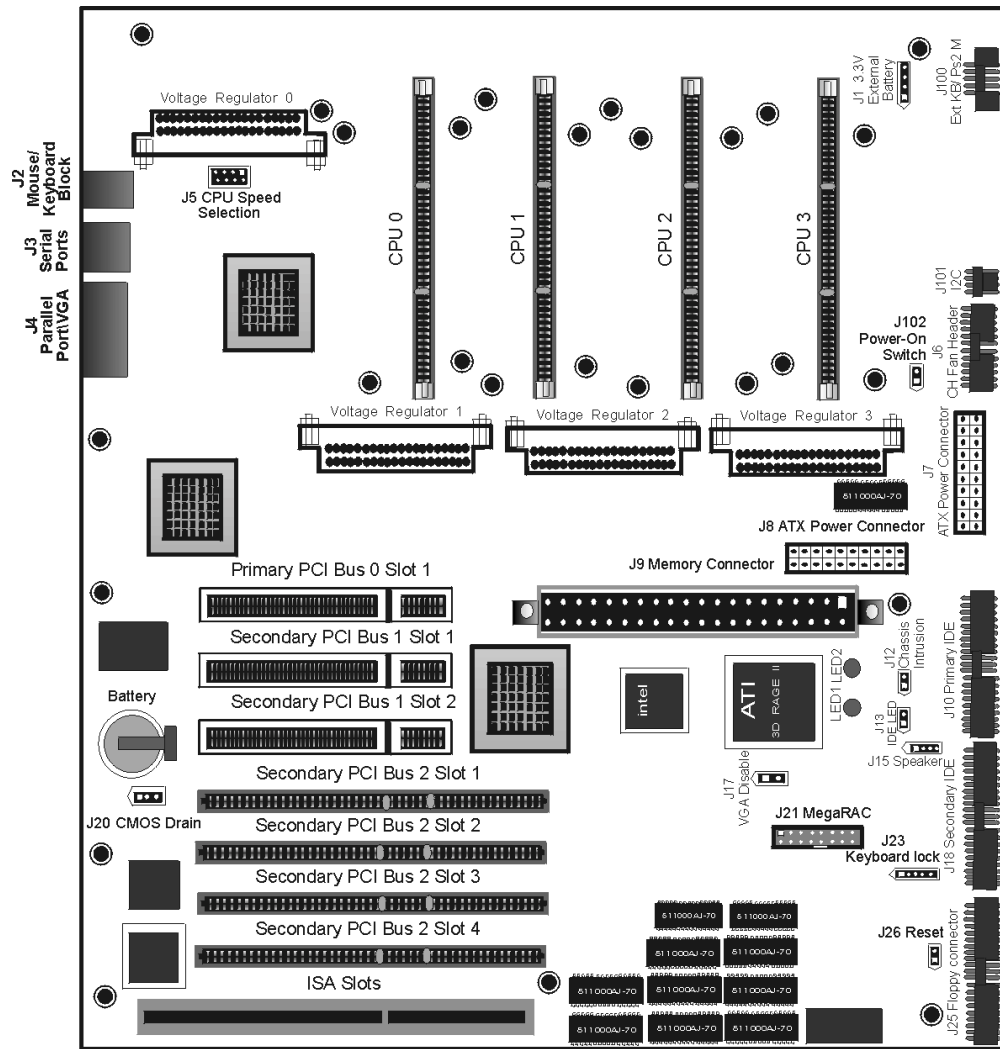

Cont'd

Megaplex II Dimensions, Continued

CPU Termination Card The CPU termination board is 6" by 4.75".

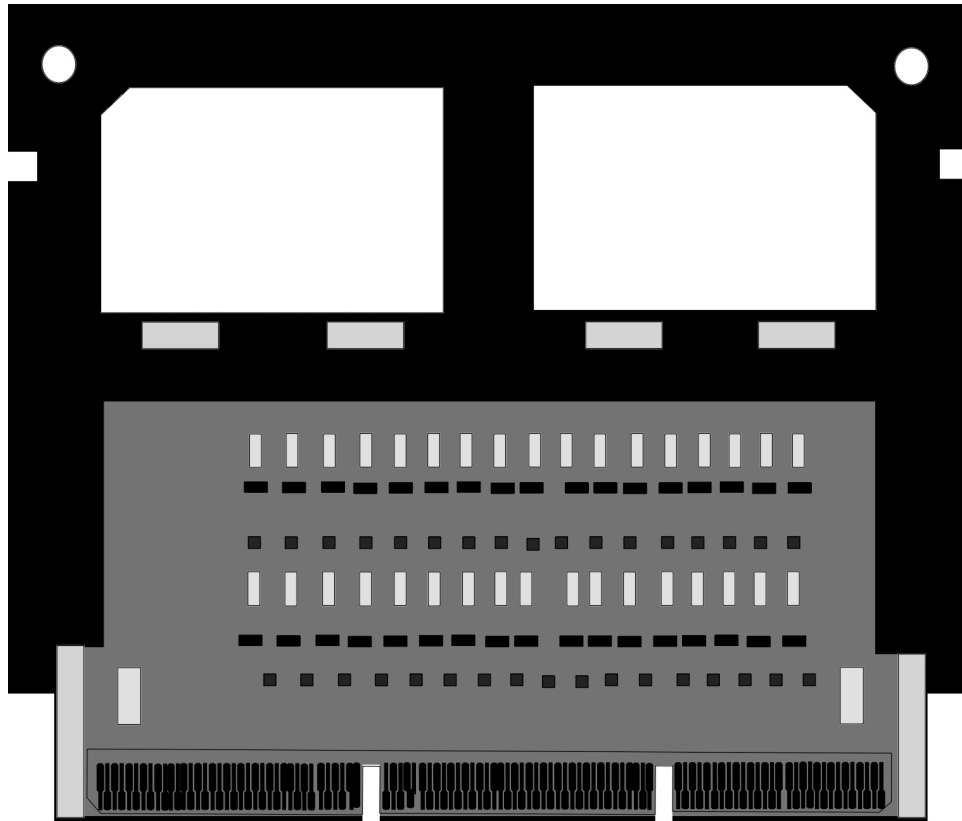

Cont'd

Megaplex II Dimensions, Continued

Series 777 Memory Board The Series 777 memory board is 6.4" by 13".

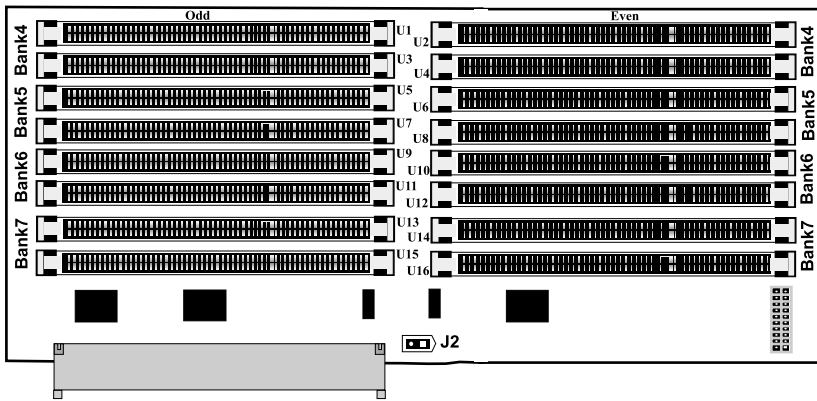

Installation Steps

Step	Action	Turn to
1	Unpack the boards.	Page 8
2	Configure board.	Page 9
3	Install memory.	Page 14
4	Install the motherboard in cabinet.	Page 18
5	Connect power supply.	Page 20
6	Attach connectors.	Page 22
7	Test and configure.	Page 35

Warning

This motherboard contains sensitive electronic components that can be easily damaged by static electricity. Follow the instructions carefully to ensure correct installation and to avoid static damage.

Avoid Static Electricity

Static electricity can damage the motherboard and other computer components. Keep the motherboard in the anti-static bag until it is to be installed. Wear an anti-static wrist grounding strap before handling the motherboard. Make sure you stand on an anti-static mat when handling the motherboard. Avoid contact with any component or connector on any adapter card, printed circuit board, or memory module. Handle these components by the mounting bracket.

Step 1 Unpack the Boards

The Megaplex II system includes the following components:

AMI Part Number	Description
Series 782	Motherboard
	Three CPU termination cards
Series 777	Memory expansion card

Step	Action
1	Inspect the cardboard carton for obvious damage. If damaged, call 770-246-8645. Leave the motherboard in its original packing.
2	Perform all unpacking and installation procedures on a ground-connected anti-static mat. Wear an anti-static wristband grounded at the same point as the anti-static mat. Or use a sheet of conductive aluminum foil grounded through a 1 megohm resistor instead of the anti-static mat. Similarly, a strip of conductive aluminum foil wrapped around the wrist and grounded through a 1 megohm resistor serves the same purpose as the wristband.
3	Inside the carton, the boards are packed in an anti-static bag, and sandwiched between sheets of sponge. Remove the sponge and the anti-static bag. Place the boards on a grounded anti-static surface component side up. Save the original packing material.
4	Inspect the boards for damage. Press down on all ICs mounted in sockets to verify proper seating. Do not apply power to the board if it has been damaged.
5	If the boards are undamaged, they are ready to be installed.

Set Jumpers Set all jumpers and install the CPU before placing the motherboard in the chassis.

Step 2 Configure Motherboard

See the drawing on page 4 for the jumper locations on the Megaplex II board.

Important

Perform the following steps to configure the boards before installing a CPU.

J5 CPU Clock Ratio J5 is an 8-pin berg on the Series 769 motherboard that sets the CPU clock ratio. The external clock speed is always 100 MHz. In the 769 motherboard graphic on page 4, Pin 1 of J3 is marked by the chamfered corner.

J5	Ratio	Internal CPU Speed
Short Pins 1-2 Short Pins 7-8	5:1	500 MHz
Short Pins 1-2 Short Pins 3-4 Short Pins 7-8	4:1	400 MHz This is the default setting.
Short Pins 5-6 Short Pins 7-8	7:2	350 MHz
Short Pins 3-4 Short Pins 7-8	9:2	450 MHz

Installing One or Multiple CPUs

Number of CPUs to be Installed	CPU Installation
1 - 3	Install one to three CPUs in the CPU sockets and install a CPU terminator card (or cards) in the remaining CPU slots.
4	Install CPUs in all four CPU sockets.

Cont'd

Step 2 Configure Motherboard, Continued

Warning

Improper CPU installation can damage the CPU and the motherboard. You must follow the procedures in this section exactly as documented. Make sure you wear an antistatic wristband while installing the CPU. Follow all antistatic procedures described on page 7.

Install CPUs You must mount the CPU Retention Unit before the CPU is installed. Also the heatsink (provided in the kit) should be mounted on the CPU before the CPU is inserted in the slot. The retention mechanism includes:

- base mechanism (4 pieces),
- top covers (4 pieces),
- ears (8 pieces),
- pegs (4 pieces), and
- screws (6-32, ¼ inch) with nuts (16 pieces).

If you plan to use heat sinks other than the ones provided in the kit, make sure that the CPU mounts properly in the retention mechanism with the heat sinks mounted on them.

Mount Retention Unit and Heat Sink

Step	Action
1	Take one base mechanism and place it directly over the CPU Slot 0 (U11). The position of the mounting holes on the mechanism is asymmetric so that the unit can be placed in only one position over the slot. The mounting holes on the mechanism superimpose over the mounting holes on the CPU board.
2	Insert one screw from the bottom of the board in a mounting hole, and tighten a nut on it from the top. Repeat for the other three holes. Do not use excessive force to tighten the screws, as this can damage the board/retention unit.
3	Repeat step 1 for Slot 1 (U12), Slot 2 (U13) and Slot 3 (U14).

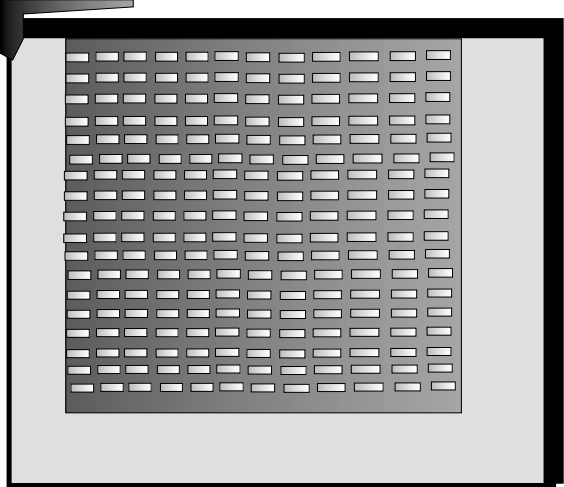
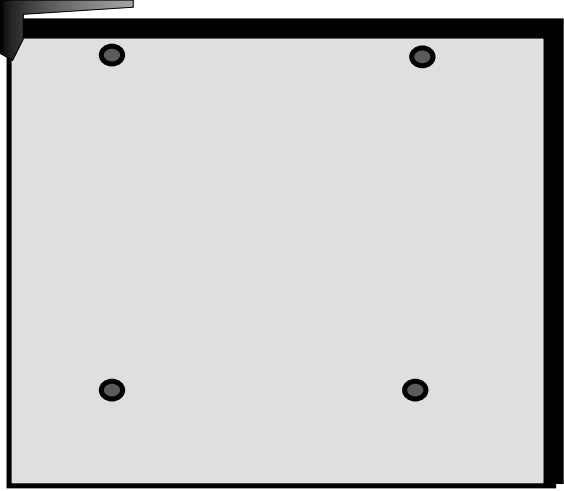
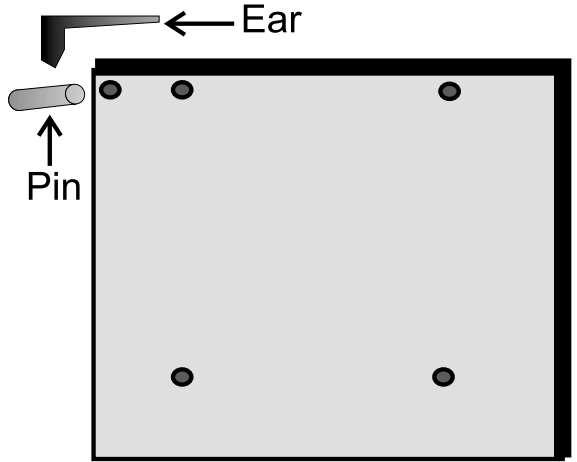
Step	Action
4	<p data-bbox="493 226 899 254">Mount the heatsink on the CPU as shown:</p>  <p data-bbox="493 772 1198 827">The CPU has 5 mounting holes on the metal side. Use only the 4 holes as shown, and screw the heatsink tightly onto the CPU.</p> 
5	<p data-bbox="493 1323 1198 1377">Mount ears on the CPU as shown. There are two holes on both the top edges of the CPU, on both sides. Use them to insert the ears into position.</p> 
6	<p data-bbox="493 1864 1013 1892">Repeat step 3, 4 and 5 for all the CPUs to be installed.</p>
7	<p data-bbox="493 1900 1214 1997">Slide the CPUs in their respective slots from the top. Both the CPU and the Retention unit have a notch on one side, to prevent the CPU from sliding into the slot with wrong polarity. Make sure the CPUs are inserted with the right polarity.</p>

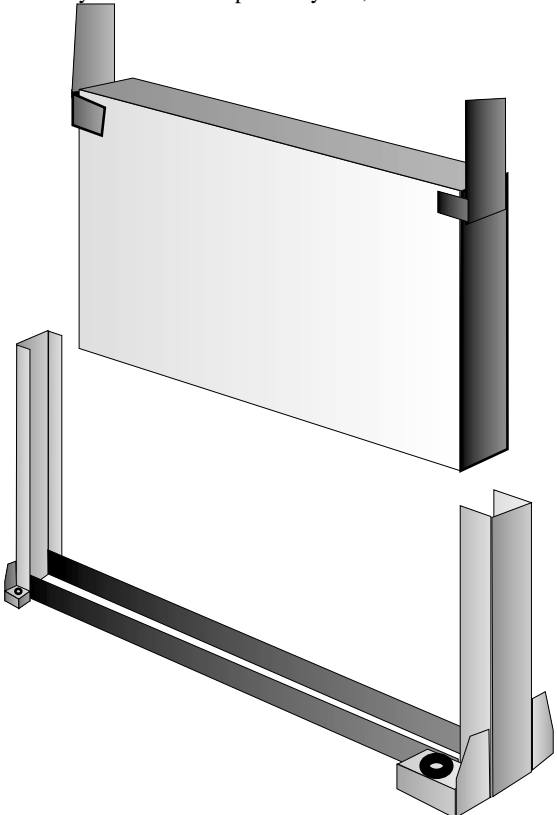
Step	Action
8	<p>Push the CPUs all the way to the bottom. When the CPU is seated properly, the ears cannot be in a standing position. Feel the ears to make sure they cannot stand up. If they can, the CPU needs to be pushed further.</p> 
9	<p>To pull the CPUs out, just pull the two ears upward into the standing position, and the CPU will be free from the socket.</p>
10	<p>Insert the pegs into position – two between Slot 0 and Slot 1, and the other two between Slot 2 and Slot 3. Make sure they go in the right position, and are seated properly, or the Top unit cannot be mounted.</p>
11	<p>Insert the top units in position. The units are polarized and can be inserted in only one direction. The polarity is shown with the dots. The end with the single dot goes in first, and at an inclination. The top will not sit properly if it is inserted vertically or horizontally to the board.</p>
12	<p>To latch the other end, push lightly from both the top and the side. You will hear a click when the attachment fits into place. The CPUs and the retention mechanism should be secured now.</p>

Cont'd

Step 2 Configure Motherboard, Continued

Termination Card The Megaplex II motherboard is shipped with CPU termination cards that should be installed in the empty CPU slots.

You must install termination cards in the empty CPU slots if you install less than four Pentium II Xeon /Pentium III Xeon CPUs. A green LED (LED2) lights up if all four CPU slots are not occupied or the cards or CPUs are not inserted properly, and the board is powered (see drawing on page 4 for location.)

Install Jumpers Install jumpers as shown in the following tables.

J20 CMOS Drain J20 is a 3-pin jumper that can be used to erase the contents of CMOS RAM, where all system configuration information is stored.

CMOS Drain	J2 Setting
Normal operation (factory setting)	Short Pins 1-2
Drain CMOS	Short Pins 2-3

J17 VGA Disable J17 is a 2-pin jumper that enables the onboard VGA.

VGA Disable	J16 Setting
Enable onboard VGA (factory setting)	OPEN
Disable onboard VGA	Short

Step 3 Install Memory

System Memory System memory for the Megaplex II is mounted on the Series 777 memory card, which supports up to 4 GB of system memory. Use 60/50 ns x 72 EDO Mode 3.3V 168-pin ECC buffered memory module DIMMs (Dual Inline Memory Modules).

The DIMMs in Megaplex II are different from the x 36 SIMMs used by most other motherboards. The Megaplex II memory modules are a new JEDEC-standard defined for 8-byte wide common CAS memory supported by most memory manufacturers. Computers that require a large amount of memory (such as servers) use DIMMs.

System Memory Requirements You must install DIMMs in all four slots of a bank. The four memory banks are Bank4, Bank5, Bank6, and Bank7 on the memory board. Each bank of memory has four DIMM sockets.

Within a memory bank, all system memory must be of the same type. Mixing different types of DIMMs is not permitted.

Use only AMI recommended memory modules.

For 2-bank ABP You can use ABP (Address Bit Permuting) to improve system performance. For 2-bank ABP:

- Two banks must be populated consecutively starting from Bank4, and
 - Two banks must have the same size and type of memory.
-

For 4-bank ABP All four banks must be populated consecutively starting from Bank4, and

All four banks must have the same size and type of memory.

BIOS will display 2-bank ABP/ 4-bank ABP (if configured correctly) after system information box.

Cont'd

Step 3 Install Memory, Continued

System Memory Specifications

Item	Description
General	3.3 volt, 168 pin, x 72, ECC DIMM (Dual Inline Memory Module) buffered memory module, EDO 50/60 ns RAS Access Time.
Voltage	The memory chips used on the module must be 3.3 volt parts.
Pinout	The module pinout is 168 pin (instead of 72 pins on SIMMs).
Data Bits	The memory modules are 72 data bit modules
No ECC	It is "raw" single CAS DRAM. There is NO ECC logic on the memory module. ECC (Error Correction Code) is implemented in the motherboard chipset. ECC does not require parity chips.
Buffers	3.3V volt buffers (typically 163244 or 16244LVT) are used to buffer the CAS, Address lines, and Write enables. The x 72 ECC modules are buffered. The Megaplex II memory card cannot use unbuffered memory modules.
Mode	Buffered EDO memory (Fast Page Mode is not supported).
DIMM Types	2 Mx72, 4 Mx72, 8 Mx72, 16 Mx72, and 32 Mx72.
Speed	60 ns/50 ns

Maximum Memory Up to 16 DIMMs can be installed to provide up to 4 GB of system memory. The minimum memory configuration should be four 2 M x 72 DIMMs (64 MB of system memory) installed in bank4. You cannot mix memory types within a memory bank.

DRAM Specifications The total amount of system memory is automatically detected by AMIBIOS. System memory is always four-way interleaved.

DRAM system memory must be populated one bank at a time. All DIMMs in a bank must be of the same memory type. Each socket can hold one DIMM. You can use:

- 2 M x 72,
- 4 M x 72,
- 8 M x 72,
- 16 M x 72, or
- 32 M x 72 DIMMs.

"M" in the above list stands for megabits.

Cont'd

Step 3 Install Memory, Continued

DRAM Configurations On the memory board, the following configurations can be used:

Bank0	Bank1	Bank2	Bank3	Total
2Mx72	None	None	None	64 MB
2 Mx72	2 Mx72	None	None	128 MB
2 Mx72	2 Mx72	2 Mx72	None	192 MB
2 Mx72	2 Mx72	2 Mx72	2 Mx72	256 MB
4 Mx72	None	None	None	128 MB
4 Mx72	4 Mx72	None	None	256 MB
4 Mx72	4 Mx72	4 Mx72	None	384 MB
4 Mx72	4 Mx72	4 Mx72	4 Mx72	512 MB
8 Mx72	None	None	None	256 MB
8 Mx72	8 Mx72	None	None	512 MB
8 Mx72	8 Mx72	8 Mx72	None	768 MB
8 Mx72	8 Mx72	8 Mx72	8 Mx72	1 GB
16 Mx72	None	None	None	512 MB
16 Mx72	None	None	None	1 GB
16 Mx72	16 Mx72	16 Mx72	None	1.5 GB
16 Mx72	16 Mx72	16 Mx72	16 Mx72	2 GB
32 Mx72	None	None	None	1 GB
32 Mx72	32 Mx72	None	None	2 GB
32 Mx72	32 Mx72	32 Mx72	None	3 GB
32 Mx72	32 Mx72	32 Mx72	32 Mx72	4 GB

There is no restriction to the sequence in which the banks are populated (in the table above, a sequence has been followed due to space restrictions), but to take advantage of ABP, you must follow the rules previously mentioned.

Cont'd

Step 3 Install Memory, Continued

Installing DIMMs The Series 777 Memory Card has 16 x 72 DIMM sockets. These sockets can be filled with either 2 MB x 72, 4 M x 72, 8 M x 72, 16 M x 72, or 32 M x 72 DIMMs.

Place the Memory Card on an anti-static mat. Each DIMM socket has a latch on either end. You cannot open all the latches at one time, so open one column at a time, install a DIMM, and then open the second column. With the component side of the DIMM facing you, insert the DIMM into the socket and secure the latches on either end of the DIMM, as shown below:

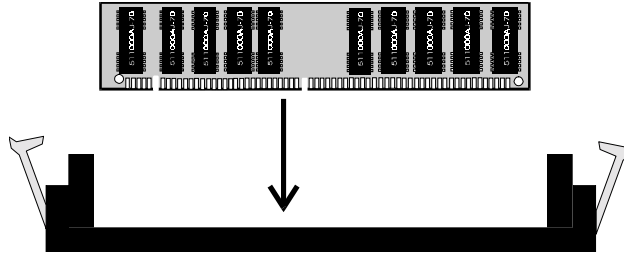

Populate the CPU board the same way. If you do not use the memory card, populate only the CPU board.

50 ns DRAM If using 50 ns DRAM, you must set the jumper J2 on the Series 777 memory board:

Jumper	
J2	Select DRAM Speed. J2 is a two-pin berg
Short	50 ns EDO DRAM
OPEN	60 ns EDO DRAM (factory setting)

DIMM with Latches Secured

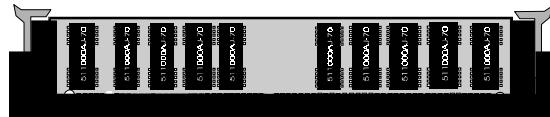

Install Memory Card Insert the Memory Card in the motherboard **after** you install the motherboard in the computer case (see Step 5 on the following page).

Step 4 Install Motherboard

The motherboard mounting hole pattern is custom made. The chassis manufacturer should supply standoffs, and screws. The hole pattern on the chassis should match the pattern on the board.

Step	Action
1	Place the chassis on an anti-static mat. Connect the chassis to ground to avoid static damage during installation. Connect an alligator clip with a wire lead to any unpainted part of the chassis. Ground the other end of the lead at the same point as the mat and the wristband.
2	Carefully slide the motherboard (Series 782) into the chassis. The motherboard should rest level with the chassis.
3	Align the mounting holes on the motherboard with the holes on the chassis. Place the mounting screws in the holes provided and tighten them.
4	Mount the memory card in the memory card socket.

Note: The memory connector, J9, on the motherboard must be occupied. If the card in J1 is not inserted properly or is uninstalled, a red LED (LED1) lights up as a warning sign, when the board is powered (see drawing on page 4 for location).

Cont'd

Step 4 Install Motherboard, Continued

Warning

If using metallic screws, make sure you use them only in the plated mounting holes. If using metallic screws, make sure the head of the screw fits completely inside the plated mounting holes. See the following graphic.

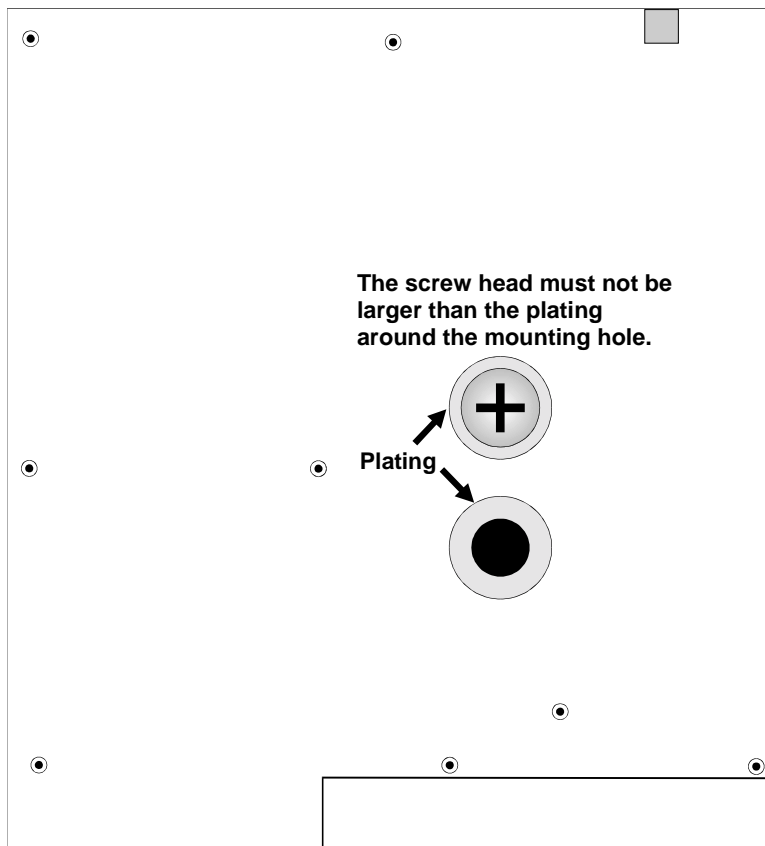

Note: The drawing above is only for illustration and does not show the exact position of the mounting holes.

Step 5 Connect Power Supply

The Megaplex II motherboard is designed to fit in a custom-built chassis. The Megaplex II requires three ATX-style power connectors. Make sure that the power switch is Off before assembly. Before attaching all components, make sure that the proper voltage has been selected. Power supplies often can run on a wide range of voltages and must be set (usually via a switch) to the proper range.

ATX Power Connectors Attach the power supply cables to the ATXPS power connectors on the motherboard, and the memory card.

Pin	Signal Description	Pin	Signal Description
1	3.3V	11	3.3V
2	3.3V	12	-12V
3	GND	13	GND
4	+5V	14	PSON
5	GND	15	GND
6	+5V	16	GND
7	GND	17	GND
8	NC	18	-5V
9	5VSB	19	+5V
10	+12V	20	+5V

Cont'd

Step 5 Connect Power Supply, Continued

Power Requirements At a minimum, one power supply generating 80 amps at +5V and 55 amps at +3.3V must be used. A 900 watt power supply generating 85 amps at +5V, 60 amps at 3.3V, and 20 amps at +12V is recommended.

+12 Volt Requirements The Megaplex II motherboard uses only one amp at +12 volts. But the AT power supply specifications require that a +12 volt line must be available for peripheral devices, hard disk drives, and adapter cards. The +12V load depends on the +12 volt requirements of the drives and adapter cards installed in the computer. We recommend 20 amps at +12 volts.

-12V and -5V Requirements Standard output is enough.

Cooling Requirements Each CPU dissipates 50 watts of power. To maintain a junction temperature of less than 158° F (75° C), adequate cooling must be provided.

AMI provides custom-made heatsinks for the Pentium II Xeon CPU. The CPU requires cooling by convection. At a maximum ambient temperature of 35° C, airflow of 250 LFM is required above each CPU heatsink.

Note: If you plan to use different heatsinks, you must provide adequate airflow over the heatsinks to maintain a safe operating temperature.

Step 6 Attach Connectors

Connectors The Megaplex II motherboard connectors are listed below:

Number	Connector	Turn to
J1	3.3V External battery	page 23
J2	KBD / PS2 mouse	page 25
J3	Serial port 1 & 2	page 25
J4	Parallel port and VGA	page 26, 31
J25	Floppy	Page 27
J10	Primary IDE	page 29
J18	Secondary IDE	page 29
J13	IDE activity	page 30
J26	External reset	page 31
J23	Keyboard lock	page 32
J100	Keyboard frontside connector	page 32
J15	Speaker	page 32
J12	Chassis intrusion	page 32
J101	LCD panel I2C header	page 33
J6	Chassis fan header	page 33
J21	MegaRAC connector	page 34
J102	Power On switch	page 34

Cable Connector Ends When connecting chassis connectors to the motherboard, make sure to connect the correct connector end. Most connector wires are color-coded. Match the color of the wires leaving the switch or LED to the same pin on the connector end. There may be more than one connector with the same color-coded wires. If so, follow the wire to the switch or LED. All motherboard components are outlined by a white rectangular box with a broad arrow at one end. Pin 1 is always at the arrow end of the white outlined box.

Cont'd

Step 6 Attach Connectors, Continued

Connectors When connecting chassis connectors to the motherboard, make sure to connect the correct connector end. Most connector wires are color-coded. Match the color of the wires leaving the switch or LED to the same pin on the connector end. There may be more than one connector with the same color-coded wires. If so, follow the wire to the switch or LED. Pin 1 is always indicated by an arrow, as shown below:

Pin 1



J1 3.3V External battery connector J1 is a 4-pin berg used for external battery connections. The pinout is:

Pin	Description
1	+3.3V
2	Not connected
3	GND
4	GND

Cont'd

Step 6 Attach Connectors, Continued

Onboard Adapters The Megaplex II has two sets of keyboard and mouse ports. The primary keyboard and mouse ports are located on the front of the chassis, to the left of the floppy disk drive. The keyboard and mouse ports on the back of the Megaplex II are maintenance ports.

The Megaplex II I/O connector block on the back of the unit includes:

- a standard PS/2 mouse connector,
- a standard PS/2 keyboard connector,
- two serial ports,
- a parallel port, and
- onboard VGA controller connector.

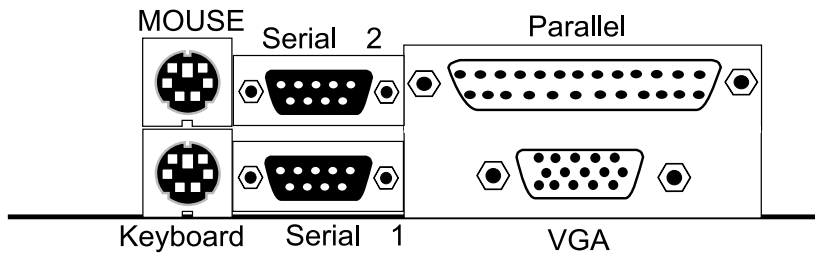

Additional I/O Connectors The Megaplex II also has:

- an IDE controller (J10 and J18 are IDE connectors), and
- a floppy connector (J25).

Conflicts

AMIBIOS minimizes conflicts between onboard and offboard I/O devices. AMIBIOS automatically checks the adapter cards installed in the expansion slots on the Megaplex II motherboard for a hard disk or floppy controller and serial or parallel ports.

Cont'd

Step 6 Attach Connectors, Continued

PS/2 Mouse Connector The PS/2 mouse 6-pin miniDIN connector is located above the PS/2 miniDIN keyboard connector in the I/O connector block on the back of the unit (as shown on page 24.) The pinout is:

Pin	Signal Description
1	Mouse Data
2	N/C
3	GND
4	VCC
5	Mouse Clock
6	N/C

PS/2 Keyboard Connector The keyboard 6-pin miniDIN connector is located below the mouse connector on the connector I/O block on the back of the unit (as shown on page 24.) The pinout is:

Pin	Signal Description
1	Keyboard Data
2	N/C
3	GND
4	VCC
5	Keyboard Clock
6	N/C

J3 Serial Connectors J3 includes two standard 9-pin D-type connectors are in the I/O connector block. The serial port base I/O port address and other settings can be selected in Peripheral Setup in AMIBIOS Setup. The serial connector pinout is:

Pin	Signal Description	Pin	Signal Description
1	Carrier Detect	6	Data Set Ready
2	Receive Data	7	Request to Send
3	Transmit Data	8	Clear to Send
4	Data Terminal Ready	9	Ring Indicator
5	GND		

Cont'd

Step 6 Attach Connectors, Continued

J4 Parallel Port Connector J4 includes a standard 26-pin parallel port connector and a VGA connector in the I/O block connector. The parallel pinout is shown below. Parallel port settings can be configured in Peripheral Setup in AMIBIOS Setup.

Pin	Signal Description	Pin	Signal Description
1	STROBE#	2	PD0
3	PD1	4	PD2
5	PD3	6	PD4
7	PD5	8	PD6
9	PD7	10	ACK#
11	BUSY	12	PE
13	SLCT	14	AUTOFD#
15	ERROR#	16	INIT#
17	SLCTIN#	18	GND
19	GND	20	GND
21	GND	22	GND
23	GND	24	GND
25	GND		

Cont'd

Step 6 Attach Connectors, Continued

J25 Floppy connector J25 is a 34-pin dual-inline shrouded connection. Connect the cable from the floppy drive to J14, as shown below. Choose Standard Setup and Peripheral Setup to configure the floppy controller.

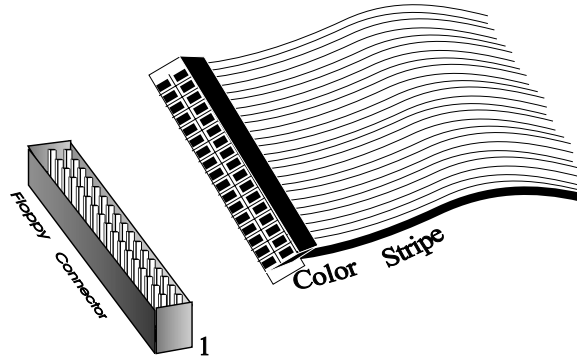

The motherboard supports up to two 720 KB, 1.44 MB, or 2.88 MB 3½" drives and 360 KB and 1.2 MB 5¼" drives. The connecting cable is a 34-pin ribbon connector with two 34-pin edge connectors for attaching the floppy disk drives. There is a small twist in the cable between the floppy connectors. The last (end) connector should be connected to floppy drive A: as shown below.

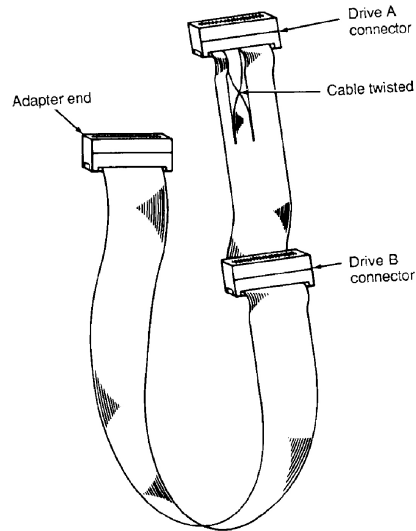

Cont'd

Step 6 Attach Connectors, Continued

J25 Floppy Connector Pinout

Pin	Use	Pin	Use
1	GND	2	DENSE1
3	GND	4	N/C
5	GND	6	DRATE0
7	GND	8	-INDEX
9	GND	10	-MOTOR0
11	GND	12	-FDSEL1
13	GND	14	-FDSEL0
15	GND	16	-MOTOR1
17	GND	18	DIR
19	GND	20	-
21	GND	22	-WDATA
23	GND	24	-WGATE
25	GND	26	-TRK0
27	GND	28	-WRPROT
29	GND	30	-RDATA
31	GND	32	HDSEL
33	GND	34	DSKCHNG

Twist in Floppy Cable

Floppy B to A	Floppy B to A	Floppy B to A	Floppy B to A
10 to 16	12 to 14	14 to 12	16 to 10
11 to 15	13 to 13	15 to 11	

Cont'd

Step 6 Attach Connectors, Continued

Attach IDE Cable J10 and J18 are the IDE (Integrated Drive Electronics) hard disk drive connectors. The primary master and the primary slave IDE drives are connected by cable to J10, as shown below.

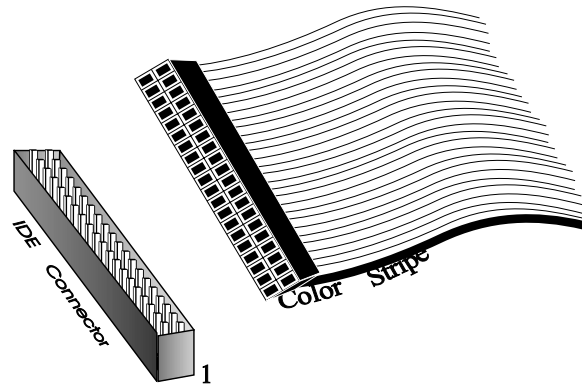

J10 is a 40-pin dual-inline shrouded connector that connects an ATA IDE drive to the primary onboard IDE connector. This motherboard supports IDE Mode 0 and LBA (Logical Block Address) mode, high capacity drives (over 528 MB), 32-bit data transfer, and fast IDE transfer. These IDE features are configured in Peripheral Setup in the AMIBIOS Setup utility.

J18 is similar to J10 and can be used as an additional IDE connector.

Cont'd

Step 6 Attach Connectors, Continued

J10 and J18 Pinout The J10 and J18 pinout is:

Pin	Use	Pin	Use
1	-RESET	2	GND
3	DATA7	4	DATA8
5	DATA6	6	DATA9
7	DATA5	8	DATA10
9	DATA4	10	DATA11
11	DATA3	12	DATA12
13	DATA2	14	DATA13
15	DATA1	16	DATA14
17	DATA0	18	DATA15
19	GND	20	KEY (N/C)
21	N/C	22	GND
23	-IOW	24	GND
25	-IOR	26	GND
27	IDERDY	28	ALE
29	N/C	30	GND
31	INT14	32	-IOCS16
33	HA1	34	N/C
35	HA0	36	HA2
37	-CS0	38	-CS1
39	-IDEACT	40	GND

J13 IDE Indicator LED J13 is a two-pin berg that is attached via a cable to the externally-mounted IDE Activity LED. This LED lights when the IDE drive is running. Pin 1 is Anode. Pin 2 is Cathode.

Warning

In some IDE drives, you may have to disable the IDE LED mounted on the drive by changing a jumper or setting a switch on the IDE drive itself, before the IDE drive sends a signal to this berg .

Cont'd

Step 6 Attach Connectors, Continued

J4 VGA Connector J4 is a standard DB15 VGA connector for the onboard ATI Rage II PCI VGA controller is in the I/O connector block. The onboard VGA is enabled by default. You can disable the onboard VGA by placing a jumper on J17. Connect a VGA monitor to this connector via a standard VGA cable. The pinout for the standard female DB15 VGA connector is shown below:

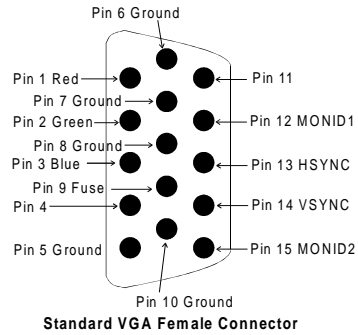

Note: If you want to disable the onboard VGA, short J17 and install a VGA card in J11 (PCI Slot1, Bus0.) An external PCI video card is supported in this slot only.

J26 External Reset J26 is a two-pin single-inline berg that is attached via a cable to an externally-mounted reset switch. When the reset switch is pressed, the system performs a hard reset. Pin 2 is Ground and Pin 1 is Hard Reset.

Cont'd

Step 6 Attach Connectors, Continued

J23 Keyboard Lock J23 is a five-pin single-inline berg that is attached via a cable to the keyboard lock connector. The computer chassis may not include the keyboard lock and Power LED on a single connector. The keyboard lock allows you to lock the keyboard.

Pin	Description
1	+5V, through pull-up resistor
2	GND
3	GND
4	Keyboard Lock
5	GND

J100 Keyboard Frontside Header J100 is an extension of the keyboard/mouse connection. It can be used for additional frontside keyboard and mouse sockets. The pinouts are as follows:

Pin	Signal Description	Pin	Signal Description
1	Keyboard Data	6	Mouse Data
2	Keyboard Clk	7	Mouse Clock
3	Keyboard GND	8	Keyboard GND
4	+5V	9	+5V
5	Keyboard GND-2	10	Keyboard GND-2

J15 Speaker Connector J15 is a four-pin single-inline berg attached via a cable to a standard system speaker. AMIBIOS signals hardware problems through the speaker.

Pin	Description
1	Data Out
2	NC
3	GND
4	+5V

J12 Chassis Intrusion Connector J12 is a 2-pin berg which should be connected by a cable to a NC (Normally Closed) switch on the chassis. The internal circuitry, when activated, monitors the state of the chassis, and informs the administrator if the chassis is opened.

Cont'd

Step 6 Attach Connectors, Continued

J101 LCD Panel I2C header J101 is a 4-pin berg connector connected by a cable to the LCD panel on the chassis. The system communicates to the I2C device on the LCD panel through this connector. The pinout is:

Pin	Description
1	I2C Clock
2	GND
3	I2C Data
4	GND

J6 Chassis Fan Header J6 is a 26-pin dual-in-line berg connected by a cable to the chassis fans, and the CPU Activity LEDs. The internal circuitry monitors the state of the chassis cooling fans and informs the administrator of any failure. The +12V pins supply power to the fans, while the fan pins read the tachometer lines of their respective fans. Up to six fans can be monitored at a time. Four lines provide information about the CPU activity. The J6 pinout is:

Pin	Description	Pin	Description
1	+12V	2	+12V
3	Fan 0	4	Fan 3
5	GND	6	GND
7	+12V	8	+12V
9	Fan 1	10	Fan 4
11	GND	12	GND
13	+12V	14	+12V
15	Fan 2	16	Fan 5
17	GND	18	GND
19	CPU 0 Act.	20	CPU 2 Act.
21	GND	22	GND
23	CPU 1 Act.	24	CPU 3 Act.
25	GND	26	GND

Cont'd

Step 6 Attach Connectors, Continued

J21 AMI MegaRAC Connector J21 is a shrouded 20-pin connector connected by a cable to the AMI RAC (Remote Access Control) expansion card. The administrator can remotely control the system, if the RAC is implemented. This connector is custom made for the AMI MegaRAC card. The pinout is:

Pin	Description	Pin	Description
1	SMI	2	I2C clock
3	Not connected	4	GND
5	Not connected	6	I2C data
7	Not connected	8	Not connected
9	Not connected	10	Not connected
11	Reset	12	GND
13	GND	14	Not connected
15	Not connected	16	GND
17	Not connected	18	Not connected
19	Not connected	20	GND

J102 Power On Switch J102 is a 2-pin berg connected by cable to the chassis power switch. The power switch is a "normally open" push button, similar to the reset button.

When the power is turned on for the first time, the system will power up normally. To turn the power off, press the soft power ON/OFF switch (connected to J102) for about five seconds. To turn the system on again, press the switch momentarily. The pinout is:

Pin	Description
1	Power
2	GND

Step 7 Test and Configure

Review the following points before powering up:

- make sure that all adapter cards are seated properly,
 - make sure all connectors are properly installed,
 - make sure the CPU is seated properly,
 - make sure there are no screws or other foreign material on the motherboard,
 - plug the system into a surge-protected power strip, and
 - make sure blank back panels are installed on the back of the chassis to minimize RF emissions.
-

Start the Test Plug everything in and turn on the switch. If there are any signs of a problem, turn off the unit immediately. Reinstall the connectors. Call Technical Support if there are problems.

BIOS Errors If the system operates normally, a display should appear on the monitor. The BIOS Power On Self Test (POST) should execute.

If POST does not run successfully, it will beep or display error messages. Beeps indicate a serious problem with the system configuration or hardware. The Beep Code indicates the problem. AMIBIOS Beep Codes are defined in the *AMIBIOS Technical Reference*. Make sure the affected part is properly seated and connected. An error message is displayed if the error is less serious. Recheck the system configuration or the connections.

Configure the System Run AMIBIOS Setup. Load the Optimal settings. Enter the requested information and save the configuration data in NVRAM (Non-Volatile Random Access Memory (also called CMOS RAM)). The system will then reset, run POST, and boot the operating system. See page 37 for information on configuring the computer.

2 AMIBIOS[®] Setup

In ISA computers, the system parameters (such as amount of memory, type of disk drives and video displays, and many other elements) are stored in CMOS RAM. Unlike the DRAM (dynamic random access memory) that is used for standard system memory, CMOS RAM requires very little power. When the computer is turned off, a back-up battery provides power to CMOS RAM, which retains the system parameters. Every time the computer is powered-on, the computer is configured with the values stored in CMOS RAM by the system BIOS, which gains control when the computer is powered on.

The system parameters are configured by a system BIOS Setup utility. Historically, BIOS Setup utilities have been character-based, required keyboard input, and have had user interfaces that were not very intuitive.

System Initialization Depending on the size of system memory, the BIOS can take up to four minutes to initialize system memory. The system memory must be initialized to support ECC (error correction). It will take the following amount of time to initialize system memory:

- 15 – 20 seconds for 512 MB,
- 45 – 60 seconds for 1 GB,
- 2:00 – 2:30 minutes for 2 GB,
- 4 minutes for 4 GB, and

If you press the Delete key during this time, BIOS will go immediately into setup. If you want a normal boot, wait the complete time for the system memory to initialize.

Starting AMIBIOS Setup As POST executes, the following appears:

Hit DEL if you want to run SETUP

Press Delete to run AMIBIOS Setup.

AMIBIOS Setup Menu

The AMIBIOS Setup main menu appears as follows. Each menu item is described in this chapter.

```
AMIBIOS HIFLEX SETUP UTILITY VERSION 1.18
© 1998 American Megatrends, Inc. All Rights Reserved.

Standard CMOS Setup
Advanced CMOS Setup
Power Management Setup
PCI / Plug And Play Setup
Peripheral Setup
Auto-Detect Hard Disks
Change User Password
Change Supervisor Password
Change Language Setting
Auto Configuration With Optimal Settings
Auto Configuration With Fail-Safe Settings
Save Settings And Exit
Exit Without Saving

Standard CMOS setup for changing time, date, hard disk type, etc.

Esc:Exit ↑↓:Sel F2/F3:Color F10:Save & Exit
```

Section 1 Standard Setup

Choose Standard CMOS Setup from the AMIBIOS Setup main menu. All Standard Setup options are described in this section. The Standard CMOS Setup screen is shown below.

AMIBIOS SETUP-STANDARD CMOS SETUP	
(C)1998 American Megatrends, Inc. All Rights Reserved	
Date (mm/dd/yyyy): Tue Sep 1,1998	Base Memory: 640 KB
Time (hh/mm/ss) : 16:05:13	Extd Memory: 255 KB
Floppy Drive A: 1.44MB 3½	
Floppy Drive B: Not Installed	
Type Size Cyln Head Wpcom Sec Mode Mode Mode Mode	
Pri Master: Auto	42 40 981 5 981 17 Off Off Auto On
Pri Slave: Not Installed	
Sec Master: Not Installed	
Sec Slave: Not Installed	
Boot Sector Virus Protection Disabled	
Month: Jan - Dec	ESC:Exit ↑↓:Sel
Day: 01 - 31	PgUp/PgDn:Modify
Year: 1901 - 2099	F2/F3:Color

Date/Time

Select Standard CMOS Setup from the AMIBIOS Setup main menu. Highlight Date or Time using the arrow keys. Enter new values through the keyboard. Press the <Tab> key or the arrow keys to move between fields. The date must be entered in MM/DD/YYYY format. The time is entered in HH:MM:SS format. The time is in 24-hour format, also. For example, 5:30 a.m. appears as 05:30:00, and 5:30 p.m. as 17:30:00.

Press <PgUp> or <PgDn> after you have selected an option to display the complete list of valid setting in the bottom section of the screen. For example, when the cursor is in the Date field, the options for month, day, and year display, as seen in the screen above.

Cont'd

Standard Setup, Continued

Floppy Drive A: and B: Move the cursor to these fields via ↑ and ↓ and select the floppy type. The settings are *360 KB 5¼ inch, 1.2 MB 5¼ inch, 720 KB 3½ inch, or 1.44 MB 3½ inch.*

Boot Sector Virus Protection This option is near the bottom of the Standard Setup screen. The settings are *Enabled* or *Disabled*. Choose *Enabled* to enable boot sector protection. AMIBIOS displays a warning when any program (or virus) issues a Disk Format command or attempts to write to the boot sector of the hard disk drive. If enabled, the following appears when a write is attempted to the boot sector. You may have to type *N* several times to prevent the boot sector write.

```
Boot Sector Write!!!  
Possible VIRUS: Continue (Y/N)? _
```

The following appears after any attempt to format any cylinder, head, or sector of any hard disk drive via the BIOS INT 13 Hard Disk Drive Service:

```
Format!!!  
Possible VIRUS: Continue (Y/N)? _
```

Cont'd

Standard Setup, Continued

Primary Master, Primary Slave, Secondary Master, Secondary Slave Select one of these hard disk drives to configure the hard disk drive named in the option. Press ENTER to autodetect. The settings for each of these drives are:

Setting	How to Configure
1 – 46 Predefined types	If you are configuring an old MFM drive and you know the drive type, select the correct drive type between 1 – 46.
USER: Enter parameters manually	If you are installing an old MFM drive and you do not know the drive type or the drive parameters do not match the drive parameters for types 1 – 46, enter the correct hard disk drive parameters.
AUTO: Set parameters automatically on each boot	<p>Select <i>Auto</i> to let AMIBIOS determine the parameters. Click on <i>OK</i> when AMIBIOS displays the drive parameters. You can also change these parameters if you do not think AMIBIOS detected the drive parameters correctly or if you want to enable an enhanced IDE feature. You can modify these parameters as follows:</p> <p>Select <i>LBA/Large Mode</i>. Select <i>On</i> if the drive has a capacity greater than 540 MB.</p> <p>Select <i>Block Mode</i>. Select <i>On</i> to allow block mode data transfers.</p> <p>Select <i>32-Bit Mode</i>. Select <i>On</i> to allow 32-bit data transfers.</p> <p>Select the <i>PIO Mode</i>. It is best to select <i>Auto</i> to allow AMIBIOS to determine the PIO mode. If you select a PIO mode that is not supported by the IDE drive, the drive will not work properly. If you are absolutely certain that you know the drive's PIO mode, select PIO mode 0 - 5, as appropriate.</p>
CDROM: Use for ATAPI CDROM drives	Select <i>CDROM</i> if configuring an ATAPI drive. AMIBIOS displays the drive parameters.
ARMD: Use for LS120, MO, Iomega Zip drives	Select this setting if you are configuring an LS120, MO (Magneto-Optical), or Iomega Zip drive.

Cont'd

Standard Setup, Continued

Entering Drive Parameters You can also enter the hard disk drive parameters. The drive parameters are:

Parameter	Description
Type	The number for a drive with certain identification parameters.
Size	The formatted size of the drive is the number of heads times the number of cylinders times the number of sectors per track times 512 (bytes per sector).
Cylinders	The number of cylinders in the disk drive.
Heads	The number of heads.
Write Precompensation	The actual physical size of a sector gets progressively smaller as the track diameter diminishes. Yet each sector must still hold 512 bytes. Write precompensation circuitry on the hard disk compensates for the physical difference in sector size by boosting the write current for sectors on inner tracks. This parameter is the track number on the disk surface where write precompensation begins.
Landing Zone	This number is the cylinder location where the heads normally park when the system is shut down.
Sectors	The number of sectors per track. MFM drives have 17 sectors per track. RLL drives have 26 sectors per track. ESDI drives have 34 sectors per track. SCSI and IDE drives have even more sectors per track.
LBA Mode	LBA (Logical Block Addressing) is a method of addressing data on a disk drive. In LBA mode, the maximum drive capacity is 8.4GB.
Blk Mode	Block mode boosts IDE drive performance by increasing the amount of data transferred. Only 512 bytes of data can be transferred per interrupt if block mode is not used. Block mode allows transfers of up to 64 KB per interrupt.
PIO Mode	IDE PIO mode programs timing cycles between the IDE drive and the programmable IDE controller. As the PIO mode increases, the cycle time decreases.
32Bit Mode	Hard disk drives connected to the computer via the ISA bus transfer data 16 bits at a time. An IDE drive on the PCI bus or VL-Bus can use a 32-bit data path.

Cont'd

Standard Setup, Continued

Hard Disk Drive Types

Type	Cylinders	Heads	Write Precompensation	Landing Zone	Sectors	Size
1	306	4	128	305	17	10 MB
2	615	4	300	615	17	20 MB
3	615	6	300	615	17	31 MB
4	940	8	512	940	17	62 MB
5	940	6	512	940	17	47 MB
6	615	4	65535	615	17	20 MB
7	462	8	256	511	17	31 MB
8	733	5	65535	733	17	30 MB
9	900	15	65535	901	17	112 MB
10	820	3	65535	820	17	20 MB
11	855	5	65535	855	17	35 MB
12	855	7	65535	855	17	50 MB
13	306	8	128	319	17	20 MB
14	733	7	65535	733	17	43 MB
16	612	4	0	663	17	20 MB
17	977	5	300	977	17	41 MB
18	977	7	65535	977	17	57 MB
19	1024	7	512	1023	17	60 MB
20	733	5	300	732	17	30 MB
21	733	7	300	732	17	43 MB
22	733	5	300	733	17	30 MB
23	306	4	0	336	17	10 MB
24	925	7	0	925	17	54 MB
25	925	9	65535	925	17	69 MB
26	754	7	754	754	17	44 MB
27	754	11	65535	754	17	69 MB
28	699	7	256	699	17	41 MB
29	823	10	65535	823	17	68 MB
30	918	7	918	918	17	53 MB
31	1024	11	65535	1024	17	94 MB
32	1024	15	65535	1024	17	128 MB
33	1024	5	1024	1024	17	43 MB
34	612	2	128	612	17	10 MB
35	1024	9	65535	1024	17	77 MB
36	1024	8	512	1024	17	68 MB
37	615	8	128	615	17	41 MB
38	987	3	987	987	17	25 MB
39	987	7	987	987	17	57 MB
40	820	6	820	820	17	41 MB
41	977	5	977	977	17	41 MB
42	981	5	981	981	17	41 MB
43	830	7	512	830	17	48 MB
44	830	10	65535	830	17	69 MB
45	917	15	65535	918	17	114 MB
46	1224	15	65535	1223	17	152 MB
	AMIBIOS automatically sets IDE drive parameters. Select USER to enter MFM, ESDI, or RLL drive parameters. Select Not Installed for SCSI drives. Select CDROM for CD-ROM drives.					

Section 2 Advanced CMOS Setup

Choose Advanced CMOS Setup from the AMIBIOS Setup main menu. Advanced CMOS Setup options are displayed by highlighting the option using the arrow keys. All Advanced CMOS Setup options are described in this section.

Primary Display This option configures the type of monitor attached to the computer. The settings are *Absent*, *VGA/EGA*, *CGA40x25*, *CGA80x25*, or *Mono*. The Optimal and Fail-Safe default settings are *VGA/EGA*.

PS/2Mouse Support Set this option to *Enabled* to enable AMIBIOS support for a PS/2-type mouse. The settings are *Enabled* or *Disabled*. If IRQ12 is required to be free for PCI cards, then you must disable this option. If you disable this option, you cannot use a PS/2-type mouse. The Optimal and Fail-Safe default settings are *Enabled*.

Pause-On Configuration Screen Set this option to pause at the configuration screen during setup. The settings are *Disabled*, *1 sec*, *2 sec*, *3 sec*, *4 sec*, *5 sec*, *6 sec*, *7 sec*, *8 sec*, *9 sec*, or *10 sec*. The Optimal and Fail-Safe default settings are *10 sec*.

BootUp Num Lock Set this option to *On* to turn the Num Lock key On at system boot. The settings are *On* or *Off*. The Optimal and Fail-Safe default settings are *On*.

Password Check This option enables the password check option every time the system boots or the end user runs Setup. If *Always* is chosen, a user password prompt appears every time the computer is turned on. If *Setup* is chosen, the password prompt appears if AMIBIOS is executed. See page 60 for instructions on changing a password. The Optimal and Power-On defaults are *Setup*.

Cont'd

Advanced CMOS Setup, Continued

Boot with Minimum Memory Select *No* to boot normally. Selecting *Yes* will allow only first 256 MB memory to be recognized, disabling the rest of the memory installed in the system.

MPS Mode Select 1.1 to boot to Unix Ware Version 7, and keep 1.4 for all other MP OS. The Optimal and Fail-Safe default settings are *1.4*.

Boot to Novell 4.X Select *Yes* to boot to Novell 3.X or 4.X. The Optimal and Fail-Safe settings are *No*.

Boot To OS/2 Set this option to *Yes* if running OS/2 operating system and using more than 64 MB of system memory on the motherboard. The settings are *Yes* or *No*. The Optimal and Fail-Safe default settings are *No*.

S.M.A.R.T. for Hard Disks Set this option to *Enabled* to permit AMIBIOS to use the SMART (Self Monitoring Analysis and Reporting Technology) protocol for reporting server system information over a network. The settings are *Enabled* or *Disabled*. The Optimal and Fail-Safe default settings are *Disabled*.

Quick Boot Set this option to *Enabled* to instruct AMIBIOS to boot quickly when the computer is powered on. The settings are *Disabled* or *Enabled*. If Quickboot is enabled, BIOS will not test the system memory; memory will be initialized only. The Optimal and Fail-Safe default settings are *Disabled*.

Cont'd

Advanced CMOS Setup, Continued

1st Boot Device This option sets the type of device for the first boot drives that the AMIBIOS attempts to boot from after AMIBIOS POST completes. The settings are *Disabled, SCSI, NETWORK, Floppy, ARMD-FDD, ARMD-HDD, ATAPI CDROM, I2O, 1st IDE-HDD, 2nd IDE-HDD, 3rd IDE HDD, or 4th IDE-HDD*. The default setting is *Floppy*. The Optimal and Fail-Safe default settings are *Floppy*.

2nd Boot Device This option sets the type of device for the second boot drives that the AMIBIOS attempts to boot from after AMIBIOS POST completes. The settings are *Disabled, SCSI, Floppy, ARMD-FDD, ARMD-HDD, ATAPI CDROM, 1st IDE-HDD, 2nd IDE-HDD, 3rd IDE HDD, or 4th IDE-HDD*. The default setting is *Disabled*. The Optimal and Fail-Safe default settings are *1st IDE*.

3rd Boot Device This option sets the type of device for the third boot drives that the AMIBIOS attempts to boot from after AMIBIOS POST completes. The settings are *Disabled, Floppy, ARMD-FDD, ARMD-HDD, ATAPI CDROM, 1st IDE-HDD, 2nd IDE-HDD, 3rd IDE HDD, or 4th IDE-HDD*. The default setting is *Disabled*. The Optimal and Fail-Safe default settings are *SCSI*.

4th Boot Device This option sets the type of device for the fourth boot drives that the AMIBIOS attempts to boot from after AMIBIOS POST completes. The settings are *Disabled, Floppy, ARMD-FDD, ARMD-HDD, ATAPI CDROM, 1st IDE-HDD, 2nd IDE-HDD, 3rd IDE HDD, or 4th IDE-HDD*. The default setting is *Disabled*. The Optimal and Fail-Safe default settings are *Disabled*.

Cont'd

Advanced Setup, Continued

Try Other Boot Devices Set this option to *Yes* to instruct AMIBIOS to attempt to boot from any other drive in the system if it cannot find a boot drive among the drives specified in the **1st Boot Device**, **2nd Boot Device**, **3rd Boot Device**, and **4th Boot Device** options. The settings are *Yes* or *No*. The Optimal and Fail-Safe default settings are *No*.

Initialize I2O Devices The settings are *Yes* or *No*. If any I2O devices are present on the system, the BIOS will initialize them.

Watch Dog Timer Set this option to *Enabled* to use the watch dog timer. If you enable the watch dog timer, the system will automatically reboot if the hardware detects no bus activity for approximately 1.2 seconds. The Optimal and Fail-Safe settings are *Disabled*.

Internal Cache This option sets the type of caching algorithm used by the L1 internal cache memory. The settings are *WriteBack*, *WriteThru*, or *Disabled*. The Optimal and Fail-Safe default settings are *WriteBack*.

System BIOS Cacheable When set to *Enabled*, the contents of the F0000h system memory segment can be read from or written to cache memory. The contents of this memory segment are always copied from the BIOS ROM to system RAM for faster execution. The settings are *Enabled* or *Disabled*. The default setting is *Enabled*. The Optimal setting is *Enabled*. The Fail-Safe setting is *Disabled*.

Cont'd

Advanced Setup, Continued

C000,16K Shadow

C400,16K Shadow This option controls the location of the contents of video ROM. The settings are:

Setting	Description
<i>Enabled</i>	The contents of the video ROM area (C0000h - C7FFFh) are written to the corresponding address in RAM.
<i>Cached</i>	The contents of the video ROM area (C0000h - C7FFFh) are written to the corresponding RAM address and can be read from or written to cache memory.
<i>Disabled</i>	The video ROM is not copied to RAM. The contents of the video ROM cannot be read from or written to cache memory.

The Optimal and Fail-Safe default settings are *Cached*.

C800,16K Shadow

CC00,16K Shadow

D000,16K Shadow

D400,16K Shadow

D800,16K Shadow

DC00,16K Shadow These options enable shadowing of the contents of the ROM area in the option title.

Setting	Description
<i>Enabled</i>	The contents of the ROM area are written to the corresponding address in RAM for faster execution.
<i>Cached</i>	The contents of the ROM area are written to the corresponding RAM address and can be read from or written to cache memory.
<i>Disabled</i>	The ROM is not copied to RAM. The contents of the video ROM cannot be read from or written to cache memory.

The Optimal and Fail-Safe default settings are *Cached*.

Section 3 Power Management Setup

Choose Power Management Setup from the AMIBIOS Setup main menu. All Power Management Setup options are described in this section.

ACPI Aware O/S Set this option to *Yes* if the operating system you are running under complies with the Intel ACPI (Advanced Configuration and Power Interface) specification. The settings are *Yes* or *No*. The Optimal and Fail-Safe default settings are *No*.

Power Button Function This option specifies how the power button mounted externally on the computer chassis is used. The settings are:

Setting	Description
On/Off	Pushing the power button turns the computer on or off.
Suspend	Pushing the Power button places the computer in Suspend mode or Full On power mode.

The Optimal and Fail-Safe default settings are *On/Off*.

Green PC Monitor Power State This option specifies the power state that the green PC-compliant video monitor enters when AMIBIOS places it in a power saving state after the specified period of display inactivity has expired. The settings are *Stand By*, *Suspend*, or *Off*. The Optimal default setting is *Suspend*. The Fail-Safe default setting is *Stand By*.

Cont'd

Power Management Setup, Continued

Video Power Down Mode This option specifies the power state that the video subsystem enters when AMIBIOS places it in a power saving state after the specified period of display inactivity has expired. The settings are *Standby*, *Suspend* or *Disabled*. The Optimal default setting is *Stand By*. The Fail-Safe default setting is *Disabled*.

Hard Disk Power Down Mode This option specifies the power conserving state that the hard disk drive enters after the specified period of hard drive inactivity has expired. The settings are *Disabled*, *Stand By*, or *Suspend*. The Optimal default setting is *Suspend*. The Fail-Safe default setting is *Disabled*.

Hard Disk Time Out (Minute) This option specifies the length of a period of hard disk drive inactivity. When this length of time expires, the computer enters power-conserving state specified in the **Hard Disk Power Down Mode** option. The settings are *Disabled*, *1 min. (minute)*, *2 min.*, *3 min.*, *4 min.*, *5 min.*, *6 min.*, *7 min.*, *8 min.*, *9 min.*, *10 min.*, *11 min.*, *12 min.*, *13 min.*, or *14 min.* The Optimal and Fail-Safe default settings are *Disabled*.

Power Saving Type The settings are *POS*, *Sleep*, *Stop Clock*, and *Deep Sleep*. The Optimal and Fail-Safe default settings are *POS*.

Standby/Suspend Timer Unit This option specifies the unit of time used for the Standby and Suspend timeout periods. The settings are *32 sec*, *4 msec*, *4 min*, or *4 sec*. The Optimal and Fail-Safe default settings are *4 min*.

Cont'd

Power Management Setup, Continued

Standby Time Out This option specifies the length of a period of system inactivity while in Full power on state. When this length of time expires, the computer enters Standby power state. The settings are *Disabled, 4 min, 8 min, up to and including 508 minutes, in increments of 4 minutes*. The Optimal and Fail-Safe default settings are *Disabled*.

Suspend Time Out This option specifies the length of a period of system inactivity while in Standby state. When this length of time expires, the computer enters Suspend power state. The settings are *Disabled, 4 min, 8 min, up to and including 508 minutes, in increments of 4 minutes*. The Optimal and Fail-Safe default settings are *Disabled*.

Slow Clock Ratio This option specifies the speed at which the system clock runs in the Standby Mode power saving state. The settings are expressed as a percentage between the normal CPU clock speed and the CPU clock speed when the computer is in the power-conserving state. The settings are *0 - 12.5%, 12.5% - 25%, 25% - 37.5%, 37.5% - 50%, 50% - 62.5%, 62.5% - 75%, or 75% - 87.5%*. The Optimal and Fail-Safe default settings are *50% - 62.5%*.

Display Activity When set to *Monitor*, this option enables event monitoring on the video display. If set to *Monitor* and the computer is in a power saving state, AMIBIOS watches for display activity. The computer enters the Full On state if any activity occurs. AMIBIOS reloads the Standby and Suspend timeout timers if display activity occurs. The settings are *Monitor* or *Ignore*. The Optimal and Fail-Safe default settings are *Ignore*.

Cont'd

Power Management Setup, Continued

Device 6 (Serial Port 1)

Device 7 (Serial Port 2)

Device 8 (Parallel Port)

Device 5 (Floppy Disk)

Device 0 (Primary Master IDE)

Device 1 (Primary Slave IDE)

Device 2 (Secondary Master IDE)

Device 3 (Secondary Slave IDE) When set to *Monitor*, these options enable event monitoring on the specified hardware interrupt request line. If set to *Monitor* and the computer is in a power saving state, AMIBIOS watches for activity on the specified IRQ line. The computer enters the Full On state if any activity occurs. AMIBIOS reloads the Standby and Suspend timeout timers if activity occurs on the specified IRQ line.

The settings for each of these options are *Monitor* or *Ignore*. The Optimal default setting is *Ignore*, except for Device 0 (Primary Master IDE), which has an Optimal default setting of *Monitor*. The Fail-Safe default setting is *Monitor*.

Section 4 PCI/PnP Setup

Choose PCI/PnP Setup from the AMIBIOS Setup main menu. All PCI/PnP Setup options are described below.

Plug and Play-Aware OS Set this option to *Yes* if the operating system in this computer follows the Plug and Play specification. Windows 95 is PnP-aware. The settings are *Yes* or *No*. The default setting is *Yes*. The Optimal and Fail-Safe default settings are *No*.

PCI VGA Palette Snoop When this option is set to *Enabled*, multiple VGA devices operating on different buses can handle data from the CPU on each set of palette registers on every video device. Bit 5 of the command register in the PCI device configuration space is the VGA Palette Snoop bit (0 is disabled). For example: if there are two VGA devices in the computer (one PCI and one ISA) and the VGA Palette Snoop bit is:

Snoop Bit	Action
<i>Disabled</i>	Data read and written by the CPU is only directed to the PCI VGA device's palette registers.
<i>Enabled</i>	Data read and written by the CPU is directed to the both the PCI VGA device palette registers and the ISA VGA device palette registers, and the palette registers of both devices can be identical.

This option must be set to *Enabled* if an ISA adapter card installed in the system uses VGA palette snooping. The Optimal and Fail-Safe default settings are *Disabled*.

Allocate IRQ to PCI VGA Set this option to *Yes* to allocate an IRQ to a VGA adapter card that uses the PCI local bus. The settings are *Yes* or *No*. The Optimal and Fail-Safe default settings are *Yes*.

The PCI/PnP Setup options are grouped by function. The first heading is: **Primary Bus Options**

PCI Slot-1 Latency This option specifies the latency timings (in PCI clocks) for PCI devices installed in the Slot-1 expansion slot. The settings are *32, 64, 96, 128, 160, 192, 224, or 248*. The Optimal and Fail-Safe default settings are *64*.

Cont'd

PCI/PnP Setup, Continued

PCI Slot-1 IRQ Priority This option specifies the IRQ priority for PCI devices installed in the computer. The settings are *Auto*, *3*, *4*, *5*, *7*, *9*, *10*, *11*, *12*, and *14*, in priority order. If *Auto* is selected, AMIBIOS automatically determines the optimal IRQ priority order. The Optimal and Fail-Safe default settings are *Auto*.

The second heading is: **Secondary Bus-1 Options**

PCI Slot-2 Latency

PCI Slot-3 Latency This option specifies the latency timings (in PCI clocks) for PCI devices installed in the Slot-2 and Slot-3 expansion slots. The setting is *248Clks*. The Optimal and Fail-Safe default settings are *248Clks*.

PCI Slot-2 IRQ Priority

PCI Slot-3 IRQ Priority This option specifies the IRQ priority for PCI devices installed in the Slot-2 and Slot-3 expansion slots. The setting is *248Clks*. The Optimal and Fail-Safe default settings are *248Clks*.

The third heading is: **Secondary Bus-2 Options**

PCI Slot-4 Latency

PCI Slot-5 Latency

PCI Slot-6 Latency

PCI Slot-7 Latency This option specifies the latency timings (in PCI clocks) for PCI devices installed in the Slot-4, Slot-5, Slot-6, and Slot-7 expansion slots. The setting is *248Clks*. The Optimal and Fail-Safe default settings are *248Clks*.

PCI Slot-4 IRQ Priority

PCI Slot-5 IRQ Priority

PCI Slot-6 IRQ Priority

PCI Slot-7 IRQ Priority This option specifies the IRQ priority for PCI devices installed in the Slot-4, Slot-5, Slot-6 and Slot-7 expansion slots. The setting is *N/A*. The Optimal and Fail-Safe default settings are *N/A*.

Cont'd

PCI/PnP Setup, Continued

The fourth heading is: **Bus IRQ Resource Owner**

IRQ3
IRQ4
IRQ5
IRQ7
IRQ9
IRQ10
IRQ11
IRQ12
IRQ14
IRQ15

These options specify the bus that the specified IRQ line is used on. These options allow you to reserve IRQs for legacy ISA adapter cards. These options determine if AMIBIOS should remove an IRQ from the pool of available IRQs passed to devices that are configurable by the system BIOS. The available IRQ pool is determined by reading the ESCD NVRAM. If more IRQs must be removed from the pool, the end user can use these options to reserve the IRQ by assigning an *ISA* setting to it. Onboard I/O is configured by AMIBIOS. All IRQs used by onboard I/O are configured as *PCI/PnP*. IRQ14 and 15 will not be available if the onboard Triton 2 PCI IDE is enabled. If all IRQs are set to *ISA* and IRQ14 and 15 are allocated to the onboard PCI IDE, IRQ9 will still be available for PCI and PnP devices, because at least one IRQ must be available for PCI and PnP devices.

The settings are *Auto*, *Primary Bus*, *Secondary Bus1*, *Secondary Bus2*, *PnP*, *PCI*, or *ISA*. The Optimal and Fail-Safe default settings are *Auto* for IRQ5, 9, 10, and 11, *PnP* for IRQ 3, 4, 7, and 12, and *PCI* for IRQ 14, and 15.

Cont'd

PCI/PnP Setup, Continued

The fifth heading is: **DMA Resource Center**

DMA Channel 0

DMA Channel 1

DMA Channel 3

DMA Channel 5

DMA Channel 6

DMA Channel 7 These options allow you to specify the bus type used by each DMA channel. The settings are *PnP* or *ISA*. The Optimal and Fail-Safe default settings are *PnP*.

Reserved ISA Card Memory Size This option specifies the size of the memory area reserved for legacy ISA adapter cards. The settings are *Disabled*, *16K*, *32K*, or *64K*. The Optimal and Fail-Safe default settings are *Disabled*.

Reserved ISA Card Memory Address This option specifies the beginning address (in hex) of the reserved memory area. The specified ROM memory area is reserved for use by legacy ISA adapter cards.

The settings are *C0000*, *C4000*, *C8000*, *CC000*, *D0000*, *D4000*, *D8000*, or *DC000*. The Optimal and Fail-Safe default settings are *C8000*.

Section 5 Peripheral Setup

Choose Peripheral Setup from the AMIBIOS Setup main menu. All Peripheral Setup options are described below.

Onboard Floppy Controller Set this option to *Enabled* to enable the floppy drive controller (FDC) on the motherboard. The settings are *Auto* (*AMIBIOS automatically determines if the floppy controller should be enabled*), *Enabled*, or *Disabled*. The Optimal and Fail-Safe default settings are *Auto*.

Onboard Primary/Secondary IDE This option specifies the IDE channels used by the onboard IDE controller. The settings are *Disabled*, *Primary*, *Secondary*, or *Both*. The Optimal and Fail-Safe default settings are *Both*.

Onboard IDE BusMaster Set this option to *Enabled* to specify that the IDE controller on the PCI bus has bus mastering capability. The settings are *Disabled* or *Enabled*. The Optimal and Fail-Safe default settings are *Disabled*.

Onboard Primary Prefetch Set this option to allow prefetch of information from the IDR disk drives by the primary IDE controller. The settings are *Disabled*, *Master*, *Slave*, or *Both*. The Optimal and Fail-Safe default settings are *Disabled*.

Onboard Secondary Prefetch Set this option to allow prefetch of information from the IDR disk drives by the secondary IDE controller. The settings are *Disabled*, *Master*, *Slave*, or *Both*. The Optimal and Fail-Safe default settings are *Disabled*.

Cont'd

Peripheral Setup, Continued

Serial Port1 IRQ This option specifies the IRQ used by serial port 1. The settings are *Disabled*, or *IRQ4*. The Optimal and Fail-Safe default settings are *IRQ4*.

Serial Port1 Address This option specifies the base I/O port address of serial port 1. The settings are *Disabled*, *3F8h*, or *3E8h*. The Optimal and Fail-Safe default settings are *3F8h*.

Serial Port1 FIFO The settings are *Disabled* or *Enabled*. This option displays only if **Serial Port1 Address** is not set to *Disabled*. The Optimal and Fail-Safe default settings are *Disabled*.

Serial Port2 IRQ This option specifies the IRQ used by serial port 2. The settings are *Disabled*, or *IRQ3*. The Optimal and Fail-Safe default settings are *IRQ3*.

Serial Port2 Address This option specifies the base I/O port address of serial port 2. The settings are *Disabled*, *2F8h*, or *2E8h*. The Optimal and Fail-Safe default settings are *2F8h*.

Serial Port2 FIFO The settings are *Disabled* or *Enabled*. This option appears only if the **Serial Port2 Address** option is not set to *Disabled*. The Optimal and Fail-Safe default settings are *Disabled*.

Parallel Port IRQ This option specifies the IRQ used by the parallel port. The settings are *Disabled*, *IRQ7*, or *IRQ5*. The Optimal and Fail-Safe default settings are *IRQ7*.

Parallel Port Address This option specifies the address of the parallel port. The settings display only if **Parallel Port IRQ** is set to *IRQ5* or *IRQ7*. The settings are *Disabled*, *378h*, or *278h*.

Cont'd

Peripheral Setup, Continued

Parallel Port Mode This option specifies the parallel port mode. The settings display only if **Parallel Port Address** is set to *278h* or *378h*. The Optimal and Fail-Safe default settings are *ECP*. The settings are:

Setting	Description
<i>Normal</i>	The normal parallel port mode is used.
<i>EPP</i>	The parallel port can be used with devices that adhere to the Enhanced Parallel Port (EPP) specification. EPP uses the existing parallel port signals to provide asymmetric bidirectional data transfer driven by the host device.
<i>ECP</i>	The parallel port can be used with devices that adhere to the Extended Capabilities Port (ECP) specification. ECP uses the DMA protocol to achieve data transfer rates up to 2.5 Megabits per second. ECP provides symmetric bidirectional communication.
<i>Bi-Dir</i>	Data can be sent to and received from the parallel port.

Parallel Port DMA Channel This option is available only if the setting for the **Parallel Port Mode** option is *ECP*. This option sets the DMA channel used by the parallel port. The settings are *Disabled*, *DMA CH 1* or *DMA CH 3*. The Optimal and Fail-Safe settings are *Disabled*.

Section 6 Other Setup Options

Auto-Detect Hard Disks

Choose this option to let AMIBIOS automatically detect the hard disk drive parameters. The Standard CMOS Setup screen will appear after AMIBIOS has configured the drives. Press <Esc> and choose Save Settings and Exit to reconfigure the system configuration with the new hard disk drive parameters.

AMIBIOS Password Support

Two Levels of Password Protection AMIBIOS provides both a Supervisor and a User password. If you use both passwords, the Supervisor password must be set first.

The system can be configured so that all users must enter a password every time the system boots or when AMIBIOS Setup is executed, using either or both the Supervisor password or User password. The Supervisor and User passwords activate two different levels of password security.

Set the **Password Check** option in Advanced Setup (see the Advanced Setup section) by choosing either *Always* (the password prompt appears every time the system is powered on) or *Setup* (the password prompt appears only when AMIBIOS Setup is executed). The password is encrypted and stored in NVRAM.

If you select password support, you are prompted for a 1 – 6 character password. Type the password on the keyboard. The password does not appear on the screen when typed. Make sure you write it down. If you forget it, you must drain NVRAM and reconfigure.

Remember the Password Keep a record of the new password when the password is changed. If you forget the password, you must erase the system configuration information in NVRAM (Non-Volatile Random Access Memory). See page 60 for information about erasing system configuration information.

Change User Password

Select Change User Password from the AMIBIOS Setup main menu.

Enter new User password:

appears. Type the password and press <Enter>. The screen does not display the characters entered. Retype the password as prompted and press <Enter>. If the password confirmation is incorrect, an error message appears. The password is stored in NVRAM after AMIBIOS completes. The next time the system boots, a password prompt appears if the Password Check option is set to *Always*.

Change Supervisor Password

Select Change Supervisor Password from the AMIBIOS Setup main menu.

Enter new supervisor password:

appears. Type the password and press <Enter>. The screen does not display the characters entered. Retype the password as prompted and press <Enter>. If the password confirmation is incorrect, an error message appears. The password is stored in NVRAM after AMIBIOS completes. The next time the system boots, a password prompt appears if the Password Check option is set to *Always*.

Change Language Settings

This option is not implemented in this AMIBIOS.

Auto Configuration with Optimal Settings

AMIBIOS will automatically set all AMIBIOS Setup options to a complete set of default settings when you choose this option. The following appears:

Load high performance settings (Y/N) ? N

The Optimal settings are designed for maximum system performance, but may not work best for all computer applications. In particular, do not use the Optimal AMIBIOS Setup options if your computer is experiencing system configuration problems.

Auto Configuration with FailSafe Settings

AMIBIOS will automatically set all AMIBIOS Setup options to a complete set of default settings when you choose this option. The following appears:

Load failsafe settings (Y/N) ? N

The Fail-Safe settings are designed for maximum system stability, but not maximum performance. Choose the Fail-Safe AMIBIOS Setup options if your computer is experiencing system configuration problems.

Save Settings and Exit

When you have completed the system configuration changes, choose this option to leave AMIBIOS Setup and to reboot the computer so the new system configuration parameters can take effect.

Exit Without Saving

Choose this option to quit AMIBIOS Setup without making any permanent changes to the system configuration.

3 Programming the Flash ROM

The Megaplex II system uses Flash EPROM to store the system BIOS. The advantage of Flash EPROM is the EPROM chip does not have to be replaced to update the BIOS. You can actually reprogram the BIOS, using a ROM file supplied by American Megatrends.

Programming the Flash EPROM

Step	Action
1	Turn power off. Make sure the computer has a working speaker.
2	Remove the computer cover.
3	Insert the floppy disk with the S782P.ROM file in drive A:.
4	Before DOS boots, press and hold down the <Ctrl> and <Home> keys to reprogram the Flash EPROM-based AMIBIOS. The bootblock code immediately reads the A: drive, looking for the new BIOS information.
5	When the flash ROM has successfully been programmed, the computer will reboot.
6	Replace the computer cover and reboot.

Cont'd

Programming the Flash ROM, Continued

Bootblock BIOS Actions When you reprogram from system boot, the bootblock BIOS code:

- Reads S782P.ROM from the root directory of the floppy disk in drive A:.
- Erases the Flash EPROM.
- Programs the Flash EPROM with the data read from the floppy disk in drive A:.
- Generates a CPU reset, rebooting the computer.

The bootblock part of the Flash EPROM is not programmed. Should you inadvertently open the disk drive door or turn power off to the computer while programming the Flash EPROM, the bootblock will be unaffected. Simply turn power back on and begin the Flash ROM programming process again.

S782P.ROM S782P.ROM resides on a floppy disk and contains the updated main BIOS code. American Megatrends will provide this file when the AMIBIOS for the Pentium II Xeon /Pentium III Xeon ISA motherboard must be updated.

S782P.ROM must be present in the root directory of the floppy disk before the onboard Flash EPROM can be reprogrammed. The file that has the main BIOS code must be named S782P.ROM.

Cont'd

Programming the Flash ROM, Continued

Sequence of Operation The sequence of operation and expected behavior of the bootblock BIOS code is:

Step	Expected behavior
1 Look for floppy disk.	The system beeps one time before the BIOS attempts to read from floppy drive A:.
2 Look for S782P.ROM on the floppy disk.	S782P.ROM must be in the root directory of the floppy disk in drive A:. There is no beep if successful.
3 Read the floppy disk.	The floppy disk is read. There is no beep if this step is successful.
4 Check for BIOS file size.	The BIOS file size is checked. There is no beep if this step is successful.
5 Check for Flash EPROM.	The BIOS looks for an Intel i28F001BX-T Flash EPROM. It does not beep if this step is successful.
6 Erase the Flash EPROM.	Two beeps sound when the BIOS begins erasing the Flash EPROM.
7 Program the Flash EPROM.	Three beeps sound when the AMIFlash Code begins reprogramming the Flash EPROM.
8 Continue programming the Flash EPROM.	Four beeps sound when reprogramming has been successfully completed.
9 AMIFlash does a reset.	A CPU reset is generated to reboot the computer.

Cont'd

Programming the Flash ROM, Continued

Beep Codes The bootblock code produces a series of beeps during Flash ROM programming to:

- signify completion of a step (as shown on the previous page), or to
- signal an error.

Error beeps are arranged in a coded sequence and have different meanings depending on when they occur. The error beep codes and when they can occur are:

Number of Beeps	Description
1	Insert diskette in floppy drive A:.
2	The AMIBOOT.ROM file was not found in the root directory of the diskette in floppy drive A:.
3	Base memory error.
4	Flash program successful.
5	Floppy read error.
6	Keyboard controller BAT command failed.
7	No Flash EPROM detected.
8	Floppy controller failure.
9	Bootblock BIOS checksum error.
10	Flash erase error.
11	Flash program error.
12	AMIBOOT.ROM file size error.
Continuous beep	Flash Programming successful. Turn power off. The turn power on again to restart.

Bootblock Code Checkpoint Codes

Code	Description
E0h	Verify the bootblock BIOS checksum. Disable the internal cache, DMA, and interrupt controllers. Initialize the system timer. Start memory refresh.
E1h	Initialize the chipset registers. Set the BIOS size to 128K. Make the 512 KB base memory available.
E2h	Test the base 64 KB of system memory. Send the BAT command to the keyboard controller. Make sure that <Ctrl> <Home> was pressed. Verify the main system BIOS checksum.
E3h	The main system BIOS is good. Transfer control to the main system BIOS.
E4h	Start the memory test.
E5h	The memory test is over. Initialize the interrupt vector table.
E6h	Initialize the DMA and interrupt controllers.
E7h	Determine the CPU internal clock frequency.
E8h	Initialize the I/O chipset, if any.
E9h	Program the CPU clock-dependent chip set parameters.
EAh	Enable the timer and the floppy diskette interrupt. Enable the internal cache. Copy the bootblock BIOS and pass control to the bootblock BIOS in the 0000h segment.
EDh	Initialize the floppy drive.
EEh	Look for a diskette in drive A:. Read the first sector of the diskette.
EFh	Floppy read error.
F0h	Search for AMIBOOT.ROM in the root directory of the floppy diskette in drive A:.
F1h	The AMIBOOT.ROM file is not in the root directory.
F2h	Read the FAT. Analyze the FAT to find the clusters occupied by the AMIBOOT.ROM.
F3h	Start reading the AMIBOOT.ROM file, cluster by cluster.
F4h	The AMIBOOT.ROM file is not the correct size.
F5h	Disable the internal cache. Raise the Vpp. Enable Flash write and reset the Flash ROM.
FBh	Detect the flash type.
FCh	Start erasing flash blocks.
FDh	Program the Flash ROM in the E0000-EFFFFh region.
FEh	Start programming Flash at F0000-FFFFF region.
FFh	Flash programming is successful. The computer reboots.

A Specifications

Engineering Specifications

Temperature Ranges The following values are ambient temperatures inside the computer case. The board temperatures reflect the CPU heat dissipation requirements because they are the hottest motherboard components.

Frequency	Heat Sink	Minimum Air Flow over CPU	Airflow over other components	Temperature Range
400 MHz or higher	Yes	250 LFM	Not Critical	0° through 35° C ambient

You should make sure that there is adequate air flow over the CPU inside the case. The CPU Plate temperature should not rise above 75° C.

Humidity The recommended humidity range for operation of the motherboard is 20% to 80% non-condensing.

Index

1

1st Boot Device, 46

2

2nd Boot Device, 46

3

3.3V memory modules, 15

3rd Boot Device, 46

4

4th Boot Device, 46

A

ACPI Aware O/S, 49

Additional I/O Connectors, 25

Advanced Setup, 44

Allocate IRQ to PCI VGA, 53

AMIBIOS, 3

AMIBIOS Password Support, 60

AMIBIOS Setup, 37

AMIBIOS Setup Menu, 38

AMIFlash

 Beep Codes, 66

ARMD, 41

ATA IDE, 3

ATAPI support, 3

Attach connectors, 23

ATXPS power connectors, 21

Auto Configuration with FailSafe Settings, 62

Auto Configuration with Optimal Settings, 62

Auto-Detect Hard Disks, 60

B

Batteries, vi

BIOS

 Password Support, 60

BIOS Errors, 36

Block Mode, 42

Boot Sector Virus Protection, 40

Boot to Novell 4.X, 45

Boot To OS/2, 45

Boot Up Num Lock, 44

Bootblock BIOS Actions, 64

Bootblock Code Checkpoint Codes, 67

Bus IRQ Resource Owner, 55

C

Cables

 Connecting, 23, 24

Cache Bus ECC, 47

Cache Memory, 2

CD-ROM drive

 Booting from, 3

 Configuring, 41

Change Language Settings, 61

Change Supervisor Password, 61

Change User Password, 61

COM1, 26

COM2, 26

Components, 1

Configuring System, 36

Conflicts, 25

Connect Power Supply, 21

Connectors, 23

 Floppy disk, 28

 IDE Hard Disk Drive, 30

 Reset Switch, 32

 Serial ports, 26

Cooling Requirements, 22

CPU Card 1

 CPU Clock, 9

CPU Clock Ratio, 9

CPU termination card, 5

CPUs, 1

D

Date/Time, 39

Device 0 (Primary Master IDE), 52

Device 1 (Primary Slave IDE), 52

Device 2 (Secondary Master IDE), 52

Device 3 (Secondary Slave IDE), 52

Device 5 (Floppy Disk), 52

Device 6 (Serial Port 1), 52

Device 7 (Serial Port 2), 52

Device 8 (Parallel Port), 52

DIMM sockets, 18

DIMM with Latches Secured, 18

Disclaimer, vi

Display Activity, 51

DMA Channel 0, 56

DMA Channel 1, 56

DMA Channel 3, 56

DMA Channel 5, 56

DMA Channel 6, 56

DMA Channel 7, 56

DMA Resource Center, 56

DMI support, 3

DRAM Configurations, 17

DRAM Specifications, 16

E

Engineering Specifications, 69

Enhanced IDE, 3

Error Checking and Correction, 1

Exit Without Saving, 62

F

Features, 1

Figures

- Floppy drive cable, 28
- Floppy drive connector, 28
- Reset switch connector, 32
- Speaker connector, 33
- Turbo LED connector, 33

Flash EPROM

Programming, 63

Floppy Disk Connector

Pinout, 28

Floppy Drive A: and B, 40

Floppy Drive connector

Pinout, 29

G

Green PC Monitor Power State, 49

H

Hard Disk Drive Capacity, 42

Hard Disk Drive Parameters, 42

Hard Disk Drive Type D:, 41

Hard Disk Power Down Mode, 50

Hard Disk Timeout (Minute), 50

Height restrictions, 4

Humidity, 69

I

IDE drive

Configuring, 41

IDE Hard Disk Connector, 30

Install CPUs, 10

Install Memory, 15

Install Memory Card, 18

Install Motherboard, 19

Installation, 7

Installing Adapter Cards, 36

Integrated I/O, 2

Internal Cache, 47

lomega Zip drive, 41

IRQ10, 55

IRQ11, 55

IRQ12, 55

IRQ14, 55

IRQ15, 55

IRQ3, 55

IRQ4, 55

IRQ5, 55

IRQ7, 55

IRQ9, 55

ISA Expansion, 2

J

J1 3.3V External battery connector, 24

J10 Pinout, 31

J10 Primary IDE connector, 30

J100 Keyboard Frontside Header, 33

J101 LCD Panel I2C header, 34

J102 Power On Switch, 35

J12 Chassis Intrusion Connector, 33

J13 IDE activity indicator, 31

J13 IDE Indicator LED, 31

J15 Speaker connector, 33

J17 VGA Disable, 14

J18 Pinout, 31

J18 Secondary IDE connector, 30

J20 CMOS Drain, 14

J21 MegaRAC Connector, 35

J23 Keyboard Lock connector, 33

J25 Floppy connector, 28

J25 Floppy Connector Pinout, 29

J26 Reset, 32

J3 Serial Connectors, 26

J4 Parallel port connector, 27

J4 VGA Connector, 32

J44 Green PC Power, 24

J5, 9

J6 Chassis Fan Header, 34

K

Keyboard, 45

L

LBA and Block Mode support, 3

LBA Mode, 42

LS-120 drive, 41

M

Magneto-Optical drive, 41

Maximum Memory, 16

MegaPlex II system components, 8

Memory Card

Populating, 18

Monitor, 44

Motherboard

Configuring, 9

Dimensions, 4

Height restrictions, 4

Mount Retention Unit and Heatsink, 10

Mouse Support, 44

MPS Mode, 45

N

Number of Cylinders, 42

Number of Heads, 42

Number of Sectors, 42

NVRAM (Non-Volatile Random Access Memory), 60

O

Onboard Adapters, 25

Onboard Floppy Controller, 57

Onboard IDE BusMaster, 57

Onboard Primary Prefetch, 57

Onboard Primary/Secondary IDE, 57

Onboard Secondary Prefetch, 57

Onboard VGA, 3

P

- Packing List, v
- Parallel Port, 27
- Parallel Port Address, 58
- Parallel Port DMA Channel, 59
- Parallel Port IRQ, 58
- Parallel Port Mode, 59
- Password Check, 44
- Password Support
 - Levels, 60
- Pause-On Configuration Screen, 44
- PCI Bus Speed, 3
- PCI Local Bus, 2
- PCI SCSI-10 IRQ Priority, 54
- PCI SCSI-10 Latency, 54
- PCI SCSI-11 IRQ Priority, 54
- PCI SCSI-11 Latency, 54
- PCI SCSI-12 IRQ Priority, 54
- PCI SCSI-12 Latency, 54
- PCI SCSI-7 IRQ Priority, 54
- PCI SCSI-7 Latency, 54
- PCI SCSI-8 IRQ Priority, 54
- PCI SCSI-8 Latency, 54
- PCI SCSI-9 IRQ Priority, 54
- PCI SCSI-9 Latency, 54
- PCI Slot-1 Latency, 53
- PCI Slot4 IRQ Priority**, 54
- PCI specification, 3
- PCI VGA Palette Snoop**, 53
- PCI/PnP Setup**, 53
- Peripheral Setup**, 57
- Pinout
 - Parallel Port, 27
 - Serial ports, 26
- Pinouts
 - IDE Activity Indicator, 31
 - Keyboard lock, 33
 - Reset Switch, 32
- PIO Mode, 42
- Plug and Play, 3
- Plug and Play NVRAM, 3
- Plug and Play-Aware OS**, 53
- Power Button Function, 49
- Power Connectors, 21
- Power Requirements, 22
 - +12 Volt Requirements, 22
 - 12 and -5 Volt Requirements, 22
- Power Saving Type, 50
- Power Supply, 21
- Pri Master, Pri Slave, Sec Master, Sec Slave, 41
- Primary Bus Options, 53
- Primary Display, 44
- Programming the Flash ROM
 - Sequence of Operation, 65
- PS/2 Keyboard Connector, 26
- PS/2 Mouse Connector, 26
- PS/2 mouse support, 44
- PS/2Mouse Support, 44

Q

- Quick Boot, 45

R

- Reserved ISA Card Memory Address**, 56
- Reserved ISA Card Memory Size**, 56
- Resource conflicts, 25
- Rules for ABP and C2C
 - 2-bank AMP, 15
 - 4-bank ABP, 15

S

- S.M.A.R.T. for Hard Disks, 45
- S730P.ROM, 64
- Save Settings and Exit**, 62
- Secondary Bus-1 Options, 54
- Secondary Bus-2 Options, 54
- Serial port
 - Pinout, 26
- Serial port connectors, 26
- Serial Port1 Address, 58
- Serial Port1 FIFO, 58
- Serial Port1 IRQ, 58
- Serial Port2 Address, 58
- Serial Port2 FIFO, 58
- Serial Port2 IRQ, 58
- Series 777 memory board, 6
- Series 782 Motherboard, 4
- Set Jumpers, 8
- Shadow C800,16K, 48
- Shadow CC00,16K, 48
- Shadow D000,16K, 48
- Shadow D400,16K, 48
- Shadow D800,16K, 48
- Shadow DC00,16K, 48
- Slow Clock Ratio, 51
- Speaker Cable Connector**, 33
- Specifications, 69
- Standard CMOS Setup Screen, 39
- Standard Setup, 39
- Standard VGA Connector, 32
- Standby Timeout, 51
- Standby/Suspend Timer Unit, 50
- Static Electricity, v, 7
- Suspend Timeout, 51
- System BIOS Cacheable, 47
- System Keyboard, 45
- System memory
 - Installing, 18
- System Memory
 - Configuring, 15
 - Interleaved, 1
- System memory configurations, 17
- System Memory Requirements, 15
- System Memory Specifications, 16

T

- Tables
 - Floppy pinout, 29
 - Hard Disk Drive Types, 43
 - I/O conflicts, 25
 - Serial port pinout, 26
 - Speaker connector pinout, 33
 - Steps for installing motherboard, 19
 - Twist in floppy cable, 29

Technical Support, iv
Temperature Ranges, 69
Termination Card, 14
Test motherboard, 36
Testing System, 36
Try Other Boot Devices, 47

U

Unpack the Boards, 8

V

Video Power Down Mode, 50
Video Shadow C000,16K, 48
Video Shadow C400,16K, 48

W

Watch Dog Timer, 47
Web Site, iv
Write Precompensation, 42