



**Atlas PCI-III Pentium
ISA Motherboard**

User's Guide

MAN-757
10/16/98

© Copyright 1985-2010 American Megatrends, Inc.
All rights reserved.
American Megatrends, Inc.
5555 Oakbrook Parkway, Building 200,
Norcross, GA 30093

This publication contains proprietary information which is protected by copyright. No part of this publication may be reproduced, transcribed, stored in a retrieval system, translated into any language or computer language, or transmitted in any form whatsoever without the prior written consent of the publisher, American Megatrends, Inc.

Limited Warranty

Buyer agrees if this product proves to be defective, that American Megatrends, Inc. is only obligated to replace or refund the purchase price of this product at American Megatrends' discretion according to the terms and conditions on the motherboard warranty card. American Megatrends shall not be liable in tort or contract for any loss or damage, direct, incidental or consequential. Please see the Warranty Registration Card shipped with this product for full warranty details.

Limitations of Liability

In no event shall American Megatrends be held liable for any loss, expenses, or damages of any kind whatsoever, whether direct, indirect, incidental, or consequential, arising from the design or use of this product or the support materials provided with the product.

Trademarks

Intel and Pentium are registered trademarks of Intel Corporation.
MS-DOS, Microsoft Word, and Microsoft are registered trademarks of Microsoft Corporation.
AMD is a registered trademark of Advanced Micro Devices, Inc.
SMC is a registered trademark of Standard Microsystems Corporation.
IBM, AT, VGA, PS/2, OS/2, and EGA are registered trademarks of International Business Machines Corporation. XT and CGA are trademarks of International Business Machines Corporation.
Fujitsu is a registered trademark of Fujitsu America, Inc.
Motorola is a registered trademark of Motorola Corporation.
Hitachi is a registered trademark of Hitachi America, Ltd.
PNY is a registered trademark of PNY Corporation.
Oki is a registered trademark of Oki America, Inc.
NEC is a registered trademark of NEC Corporation.
Samsung is a registered trademark of Samsung Electronics Corporation.
Siemens is a trademark of Siemens Corporation.
Mitsubishi is a registered trademark of Mitsubishi Electronics of America.
Micron is a registered trademark of Micron Corporation.
SCO, UnixWare, and Unix are registered trademarks of The Santa Cruz Operation, Inc.
Toshiba is a registered trademark of Kabushiki Kaisha Toshiba.
VESA is a trademark of the Video Electronics Standards Association.
All other brand and product names are trademarks or registered trademarks of their respective companies.

Revision History

2/26/97	Initial release.
11/20/97	Added VRM information.
10/16/98	Added J4 description.

Table of Contents

1 HARDWARE INSTALLATION.....	1
Atlas PCI-III Dimensions	5
Installation Steps	6
Atlas PCI-III Motherboard Layout	7
Step 1 Unpack the Motherboard.....	8
Set Jumpers	9
Avoid Static Electricity.....	9
Step 2 Configure CPU	10
Step 3 Install Memory	15
Step 4 Install the Motherboard.....	19
Step 5 Attach Cables	20
Step 6 Onboard I/O.....	27
Step 7 Attach Floppy Drive.....	29
Step 8 Attach IDE Drive.....	31
Step 9 Test and Configure	35
2 WINBIOS® SETUP.....	37
Using a Mouse with WINBIOS Setup	38
Using the Keyboard with WINBIOS Setup.....	38
WINBIOS Setup Menu	39
Section 1 Setup.....	40
Standard Setup	40
Advanced Setup.....	44
Chipset Setup	48
Power Management Setup	49
PCI/PnP Setup.....	53
Peripheral Setup	57
Section 2 Security	61
AMIBIOS Password Support	61
Setting a Password.....	62
Changing a Password	63
Anti-Virus.....	63
Section 3 Utility	64
Section 4 Default.....	64
3 PROGRAMMING THE FLASH ROM.....	65
Bootblock Code Checkpoint Codes	68
A SPECIFICATIONS.....	69
INDEX.....	71

Preface

To the OEM Thank you for purchasing the high performance American Megatrends Atlas PCI-III Pentium ISA motherboard. This product is a state of the art motherboard that includes the famous AMIBIOS. It is assumed that you have also licensed the rights to use the American Megatrends documentation for the American Megatrends Atlas PCI-III motherboard

This manual was written for the OEM to assist in the proper installation and operation of this motherboard. This manual describes the specifications and features of the Atlas PCI-III motherboard. It explains how to assemble a system based on the Atlas PCI-III motherboard and how to use the AMIBIOS that is specifically designed for this motherboard.

This manual is not meant to be read by the computer owner who purchases a computer with this motherboard. It is assumed that you, the computer manufacturer, will use this manual as a sourcebook of information, and that parts of this manual will be included in the computer owner's manual.

Disclaimer

AMI only certifies that this product will work correctly when this product is used with the same jumper settings, the same system configuration, the same memory module parts, and the same peripherals that were tested by AMI with this product. The complete list of tested jumper settings, system configurations, peripheral devices, and memory modules are documented in the AMI Compatibility Report for this product. Call your AMI sales representative for a copy of the Compatibility Report for this product.

Technical Support

If you need help installing, configuring, or running this product, call American Megatrends technical support at 770-246-8645. You can send questions to technical support at:

support@ami.com.

Web Site We invite you to access the American Megatrends world wide web site at:

<http://www.ami.com>.

Packing List

You should have received the following:

- an Atlas PCI-III Pentium ISA motherboard,
- two serial cables,
- one parallel cable,
- a Warranty Card, and
- the *Atlas PCI-III Pentium ISA Motherboard User's Guide*.

You may also purchase an optional USB cable and mounting bracket.

Warning

The pinout for the optional USB Cable Box is:

Pin 1	Red	VCC
Pin 2	Green	Data +
Pin 3	White	Data -
Pin 4	Black	Ground

Please make sure that the USB cable is correctly installed. Incorrect installation will damage the motherboard.

Static Electricity

This motherboard can easily be damaged by static electricity. Make sure you take appropriate precautions against static electric discharge:

- wear a properly-grounded wristband while handling the motherboard or any other electrical component,
- touch a grounded anti-static surface or a grounded metal fixture before handling the Atlas PCI-III motherboard,
- handle system components by the mounting bracket, if possible.

Batteries

Make sure you dispose of used batteries according to the battery manufacturer's instructions. Improper use of batteries may cause an explosion. Make sure you follow the battery manufacturer's instructions about using the battery. Replace used batteries with the same type of battery or an equivalent recommended by the battery manufacturer.

1 Hardware Installation

Overview

The American Megatrends Atlas PCI-III Pentium ISA motherboard includes the following features.

- CPU** The motherboard supports an AMD® K6 or Intel® Pentium® P54C or P55C CPU operating at 75, 90, 100, 120, 133, 150, 166, 180, 200 MHz or higher. The CPU speed and voltage are set via jumpers.
-
- Chipset** The Atlas PCI-III Pentium ISA motherboard uses an Intel 82430HX chipset, including CPU interface controller, advanced cache controller, integrated DRAM controller, synchronous ISA bus controller, PCI local bus interface, and integrated power management unit.
-
- Expansion slots** The motherboard includes four 16-bit ISA expansion slots and four 32-bit PCI expansion slots. The PCI local bus throughput can be up to 132 megabytes per second.
-
- L1 Internal Cache** The Intel Pentium on the motherboard has an 8 KB data cache and an 8 KB instruction cache.
-
- L2 Secondary Cache** The motherboard has either 256 KB or 512 KB of synchronous Pipelined Burst SRAM, direct-mapped, write-back. L2 secondary cache memory.
-

Cont'd

Overview, Continued

DRAM Cached If 256 KB of L2 secondary cache memory is installed on the motherboard, up to 128 MB of system memory can be cached.

If 512 KB of L2 secondary cache memory is installed on the motherboard, up to 256 MB of system memory can be cached.

System Memory The motherboard supports up to 256 MB of system memory mounted on the motherboard in two banks of 72-pin 4 MB, 8 MB, or 16 MB x 36 SIMMs.

Use Fast Page Mode, ECC, or Extended Data Out (EDO) SIMMs operating at 60 ns.

Fast ATA The motherboard supports the Fast ATA specification using PIO mode 4 and multiword DMA mode 2.

System BIOS This motherboard has a 128 KB AMIBIOS system BIOS on a Flash ROM with built-in WINBIOS® Setup.

BIOS Shadowing The system BIOS is always copied from ROM to RAM for faster execution. The end user can shadow 16 KB ROM segments from C0000h – DCFFFh.

Motherboard Size The Atlas PCI-III Pentium ISA motherboard is 13 inches by 8.5 inches.

Cont'd

AMIBIOS Features AMIBIOS features include:

- IDE block mode support,
 - IDE 32-bit data transfer support,
 - IDE Programmed I/O mode 0, 1, 2, 3, and 4 support,
 - IDE LBA mode support,
 - APM (Advanced Power Management) and Flash BIOS hooks,
 - EPA Green PC-compliant,
 - PCI and Plug and Play (PnP) support, and
 - DIM (Device Initialization Manager) support,
 - DMI (Desktop Management Interface) support,
 - ATAPI support,
 - can boot from a CD-ROM drive,
 - automatically detects system memory, cache memory, and IDE drive parameters,
 - Intel NSP-compliant,
 - Fast ATA IDE mode programming,
 - Boot sector virus protection,
 - instant-on support,
 - automatically configures PnP and PCI devices.
-

IDE The Atlas PCI-III motherboard has two 40-pin IDE connectors onboard that support up to four IDE drives. The IDE controller is on the PCI local bus.

Floppy The motherboard has an onboard floppy controller that supports up to two 360 KB, 720 KB, 1.2 MB, 1.44 MB, or 2.88 MB floppy drives.

Parallel Port The Atlas PCI-III motherboard has an onboard ECP and EPP-capable parallel port connector.

Serial Ports The Atlas PCI-III motherboard has two onboard serial port connectors and two 16550 UART serial ports.

Keyboard The Atlas PCI-III motherboard includes a standard DIN keyboard connector.

Cont'd

Overview, Continued

Mouse The Atlas PCI-III motherboard includes both an optional miniDIN PS/2 mouse connector and a 10-pin berg mouse connector.

USB The Atlas PCI-III motherboard has two 4-pin USB connectors. USB allows future generations of USB-compliant peripheral devices to be automatically detected and configured through a single port. The AMIBIOS on the Atlas PCI-III motherboard provides complete USB system BIOS support.

Power Connectors The Atlas PCI-III motherboard has three power supply connectors.

RTC/CMOS RAM A real time clock and 128 bytes of CMOS RAM with a battery backup is provided on the motherboard.

Power Management Power management services include:

- Green PC LED,
 - power management signal to Green PC-aware power supplies,
 - automatic IDE and video power down,
 - monitor blanking,
 - SMI (System Management Interrupt) support,
 - APM, and
 - system stop clock.
-

Cont'd

Overview, Continued

PCI Slots The motherboard conforms to the PCI Version 2.1 specification. The PCI slots are automatically configured by the AMIBIOS. The PCI slots operate synchronously with the CPU clock, as follows:

CPU External Clock Frequency	PCI Expansion Slot Frequency
66 MHz	33 MHz
60 MHz	30 MHz
50 MHz	25 MHz

Onboard I/O The Atlas PCI-III Pentium ISA motherboard includes:

- two 40-pin IDE connectors on the PCI bus that support up to four IDE drives,
 - a 34-pin floppy drive connector,
 - two 10-pin serial port connectors (with 16550 UARTs),
 - a 26-pin parallel port connector with ECP and EPP support,
 - two USB connectors,
 - a keyboard connector, and
 - a PS/2 mouse connector.
-

Atlas PCI-III Dimensions

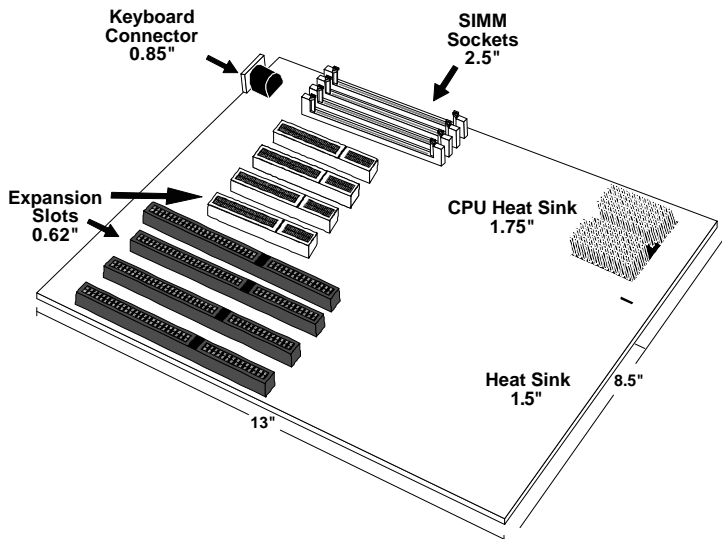

Installation Steps

Step	Action	Turn to
1	Unpack the motherboard.	Page 8
2	Configure the CPU.	Page 10
	Select the CPU voltage.	Page 11
	Select the CPU speed.	Page 10
	Install the CPU.	Page 12
3	Install memory.	Page 15
4	Install the motherboard.	Page 19
5	Attach cables to connectors.	Page 20
	Connect the power supply.	Page 21
	Attach the keyboard cable.	Page 22
	Connect the mouse cable.	Page 23
	Attach cables.	Page 24
6	Connect onboard I/O.	Page 27
	Connect the serial ports.	Page 27
	Connect the parallel port.	Page 28
7	Connect floppy drive(s).	Page 29
8	Connect the IDE drive(s).	Page 30
9	Test and configure.	Page 35





Warning

This motherboard contains sensitive electronic components that can be easily damaged by static electricity. Follow the instructions carefully to ensure correct installation and to avoid static damage.

Atlas PCI-III Motherboard Layout

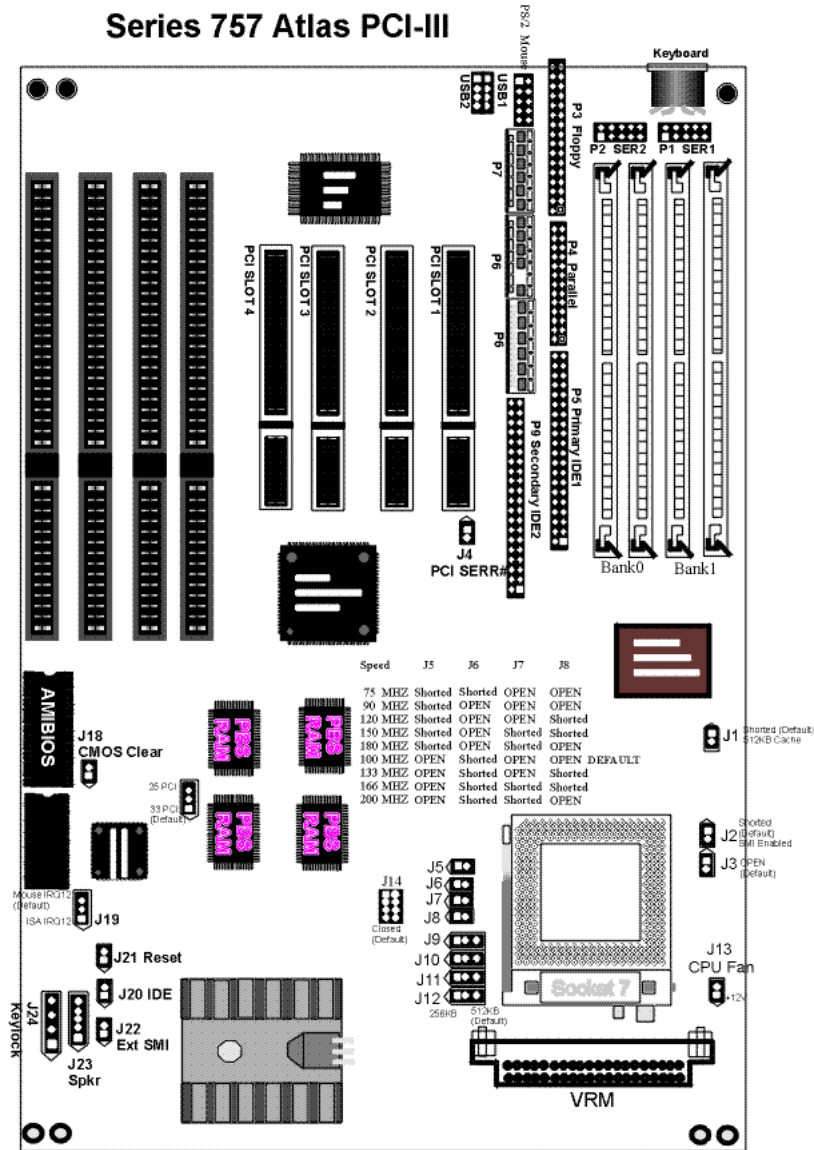
Series 757 Atlas PCI-III



A Square Pad  identifies Pin 1 in Jumpers and Connectors.

Step 1 Unpack the Motherboard

Step	Action
1	Inspect the cardboard carton for obvious damage. If damaged, call 770-246-8645. Leave the motherboard in its original packing.
2	Perform all unpacking and installation procedures on a ground-connected anti-static mat. Wear an anti-static wristband grounded at the same point as the anti-static mat. Or use a sheet of conductive aluminum foil grounded through a 1 megohm resistor instead of the anti-static mat. Similarly, a strip of conductive aluminum foil wrapped around the wrist and grounded through a 1 megohm resistor serves the same purpose as the wristband.
3	Inside the carton, the motherboard is packed in an anti-static bag, and sandwiched between sheets of sponge. Remove the sponge and the anti-static bag. Place the motherboard on a grounded anti-static surface component side up. Save the original packing material.
4	Inspect the motherboard for damage. Press down on all ICs mounted in sockets to verify proper seating. Do not apply power to the motherboard if it has been damaged.
5	If the motherboard is undamaged, it is ready to be installed.

Set Jumpers

Set all jumpers and install the CPU before placing the motherboard in the chassis. Set jumpers by placing a shunt (shorting bridge) on the designated pins of the jumper. A shunt and jumpers are shown below:

3-dimensional view of motherboard jumpers and a shunt.

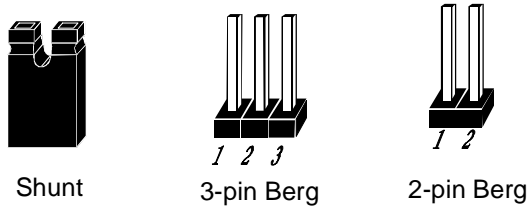

In this manual, jumpers are shown in two -dimensions, as if viewed from directly above, as shown below:

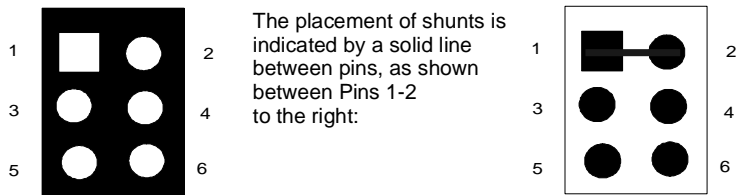

Avoid Static Electricity

Static electricity can damage the motherboard and other computer components. Keep the motherboard in the anti-static bag until it is to be installed. Wear an anti-static wrist grounding strap before handling the motherboard. Make sure you stand on an anti-static mat when handling the motherboard.

Avoid contact with any component or connector on any adapter card, printed circuit board, or memory module. Handle these components by the mounting bracket.

Step 2 Configure CPU

See the drawing on page 7 for the jumper locations.



Important

Perform the following steps to configure the motherboard before installing a CPU.

External and Internal CPU Clock J5, J6, J7, and J8 are 2-pin bergs that set the CPU external and internal clock frequencies. J5, J7, and J8 are next to the CPU socket. Place a shorting bridge on the two pins if the chart specifies that the jumper is to be shorted. Do not place a shorting bridge on the jumper if the following table specifies OPEN. See the drawing on page 7 for the exact jumper locations. The factory setting is for a 100 MHz CPU.

External	Internal	J5	J6	J7	J8
50 MHz	75 MHz	Shorted	Shorted	OPEN	OPEN
60 MHz	90 MHz	Shorted	OPEN	OPEN	OPEN
60 MHz	120MHz	Shorted	OPEN	OPEN	Shorted
60 MHz	150 MHz	Shorted	OPEN	Shorted	Shorted
60 MHz	180 MHz	Shorted	OPEN	Shorted	OPEN
66 MHz	100 MHz	OPEN	Shorted	OPEN	OPEN
66 MHz	133 MHz	OPEN	Shorted	OPEN	Shorted
66 MHz	166 MHz	OPEN	Shorted	Shorted	Shorted
66 MHz	200 MHz	OPEN	Shorted	Shorted	OPEN



Important

Please contact American Megatrends technical support at 770-246-8645 if you need to support a CPU running at a higher speed.

PCI Bus Clock J15 is a 3-pin berg that specifies the PCI bus clock speed. Short Pins 1-2 for a 66 (33) MHz CPUCLK. Short Pins 2-3 for a 75 (25) MHz CPUCLK.

Cont'd

Step 2 Configure CPU, Continued

J14 Set CPU Voltage Install Intel Pentium P54C, P55C, or AMD K6 CPUs that adhere to either the standard or VRE voltage specifications. J14 is a 2-pin berg that sets the CPU voltage.

CPU	VRM Status	J14 Setting
Intel P54C	NO VRM	Shorted (factory setting)
Intel P55C	Use a 2.8V Voltage Regulator Module in the VRM socket	OPEN
AMD K6	Use a 3.1V Voltage Regulator Module in the VRM socket	OPEN

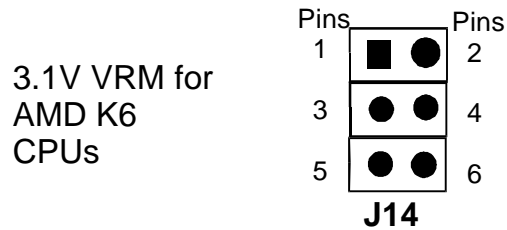
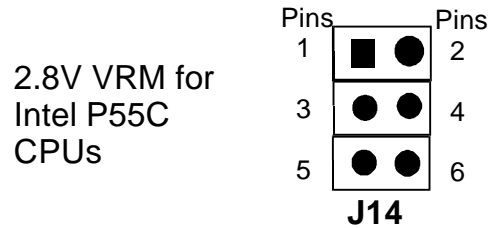
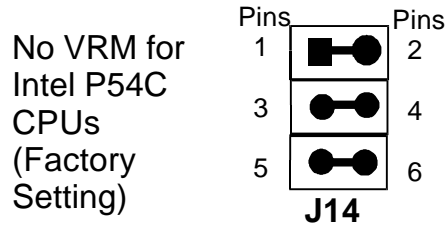

Cont'd

Step 2 Configure CPU, Continued



Important

If you are not sure about the voltage specification for the CPU that will be installed in this motherboard, please call Intel and make sure that you set the voltage jumpers correctly. Selecting the wrong voltage may damage the CPU.

Voltage Regulator Modules Use the following Voltage Regulator Modules (VRMs) in this motherboard:

CPU Type and Speed	Description	Corsair VRM7 Part Number	VXI Electronics VRM7 Part Number
Intel® P54C	Use MB 3.3V	N/A	N/A
Intel P55C up to 233 MHz	2.8V 7.5 Amps	Call AMI for AMI Part Number MDL-P55C-V2A075	Call AMI for AMI Part Number MDL-P55C-V2A075
166 or 200 MHz AMD® K6	2.9V 7.5 Amps	SP5260TS-2X9	073-20723-29
233 MHz AMD K6	3.2V 9.5 Amps	SP5260TS-3X2	073-20723-32

AMI Order Number Call AMI Sales at 800-828-9264.

VXI Contact Earlene Tyson
800-648-8978 extension 227.

Corsair Contact Corsair requires a minimum order of 50 VRMs.
John Beekly
408-559-1777.

Step 2 Configure CPU, Continued

Install CPU

Install the CPU in the ZIF (zero insertion force) socket by performing the following steps. The CPU socket is near one edge of the motherboard, as shown on page 7.





Warning

Improper CPU installation can damage the CPU and the motherboard. You must follow the procedures in this section exactly as documented. Make sure you wear an antistatic wristband while installing the CPU. Follow all antistatic procedures described on page 9.

Cont'd

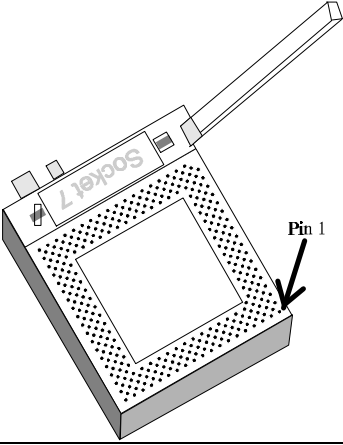
Step 2 Configure CPU, Continued

Step	Action
1	Lift the lever on the ZIF socket. The empty CPU socket looks like this. 
2	Check for bent pins on the CPU. Gently straighten any bent pins with pliers. Place the CPU in the middle of the socket. Make sure that pin 1 of the CPU is aligned with pin 1 of the socket. <i>Make sure you are properly grounded while handling the CPU.</i>
3	Complete installation by lifting the ZIF lever to the other side of the socket, as shown below. 

Enable External SMI J2 is a 2-pin berg that enables an external SMI source. Place a shorting bridge on J2 (the factory setting) to enable external SMIs.

Enable Refresh J3 is a 2-pin berg. Always make sure that J3 is OPEN.

J4 Enable PCI SERR# Signal J4 is a two-pin berg that enables the PCI SERR# signal. Always make sure that J4 is OPEN.

Step 3 Install Memory

System Memory The motherboard has four 32-bit SIMM – Single Inline Memory Module) sockets. You can use Fast Page Mode or EDO (Extended Data Out) SIMMs. Memory must be populated one bank at a time. Each bank has two sockets. Each bank must be populated with the same type of SIMM. If a 1 MB SIMM is installed in the first socket in Bank0, then the same type of 1 MB SIMM must be installed in the second Bank0 SIMM socket. Each socket can hold one 72-pin SIMM. You can use:

- 1 MB x 36,
- 4 MB x 36,
- 8 MB x 36, or
- 16 MB x 36 SIMMs.

The motherboard supports banks of fast page mode and EDO (Extended Data Out) memory together operating at 60 ns (RAS access time).

Memory Display System memory is reported by AMIBIOS as it boots and again when the AMIBIOS System Configuration Screen is displayed just before the operating system boots. The memory displayed by AMIBIOS on the System Configuration Screen is 384 KB less than the total memory installed.

SIMM Part Numbers

Type	Manufacturer	Part Number
4 MB x 36	Micron	MT12D436M-6
“	Mitsubishi	MH4M36SAJ-6
“	Motorola	MCM36400S-60
“	PNY	P364000-60
“	Samsung	KMM5364100-6
8 MB x 36	Motorola	MCM36800S-60
“	PNY	P368000-60
“	Samsung	KMM5368100-6

Cont'd

Step 3 Install Memory, Continued

DRAM Configurations Valid memory configurations include:

Total RAM	Bank0	Bank0	Bank1	Bank1
8 MB	4 MB	4 MB	None	None
16 MB	8 MB	8 MB	None	None
24 MB	8 MB	8 MB	4 MB	4 MB
32 MB	8 MB	8 MB	8 MB	8 MB
40 MB	16 MB	16 MB	4 MB	4 MB
48 MB	16 MB	16 MB	8 MB	8 MB
64 MB	16 MB	16 MB	16 MB	16 MB
64 MB	32 MB	32 MB	None	None
72 MB	32 MB	32 MB	4 MB	4 MB
80 MB	32 MB	32 MB	8 MB	8 MB
96 MB	32 MB	32 MB	16 MB	16 MB
128 MB	32 MB	32 MB	32 MB	32 MB
136 MB	64 MB	64 MB	4 MB	4 MB
144 MB	64 MB	64 MB	8 MB	8 MB
160 MB	64 MB	64 MB	16 MB	16 MB
192 MB	64 MB	64 MB	32 MB	32 MB
256 MB	64 MB	64 MB	64 MB	64 MB

Cont'd

Step 3 Install Memory, Continued

Installing SIMMs The motherboard has four x 36 SIMM sockets. These sockets can be filled with either 1 MB x 36, 4 MB x 36, 8 MB x 36, or 16 MB x 36 SIMMs.

Place the motherboard on an anti-static mat. With the component side of the SIMM facing you, firmly push the SIMM into the socket at an angle, then push it up. When properly inserted, the SIMM clicks into place as the latching pins engage. The SIMM installation process is shown below:

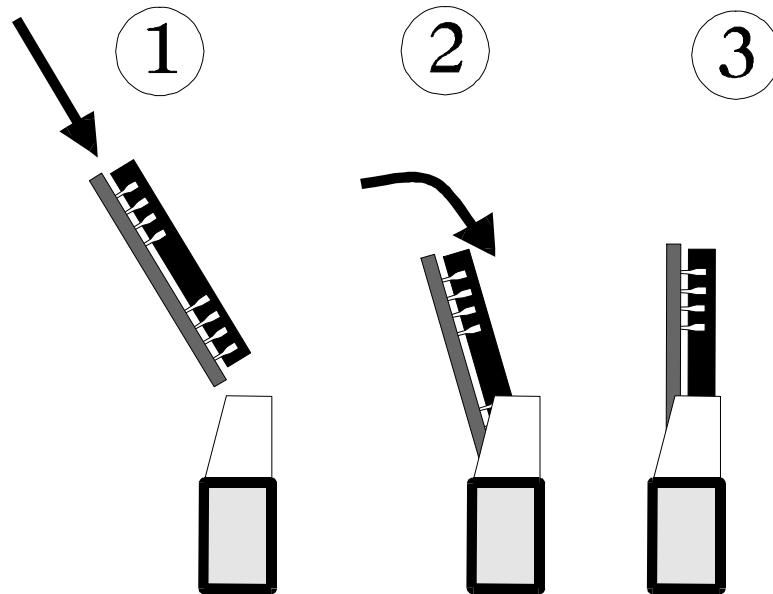

Cont'd

Step 3 Install Memory, Continued

Configure Cache Memory The motherboard supports 256 KB or 512 KB of L2 3V Pipeline Burst SRAM secondary cache memory.

J9, J10, J11, and J12 are 3-pin bergs that specify the cache memory size. These jumpers are next to the CPU socket. J1 is a 2-pin berg that also specifies the cache memory size.

Cache Size	J1	J9	J10	J11	J12
256 KB	OPEN	Short Pins 1-2	Short Pins 1-2	Short Pins 1-2	Short Pins 1-2
512 KB	Shorted	Short Pins 2-3	Short Pins 2-3	Short Pins 2-3	Short Pins 2-3

Either 256 KB or 512 KB of Pipeline Burst Mode Static RAM L2 secondary cache memory is mounted on the motherboard. *You cannot upgrade L2 secondary cache memory.*

L2 Cache Size	Cache DIP Type	Tag RAM Type
256 KB	32 KB x 32	32 KB x 8
512 KB	32 KB x 32	32 KB x 8

Step 4 Install the Motherboard

The motherboard mounting hole pattern is the same as the mounting hole pattern on the standard baby AT motherboard. Standoffs and mounting screws are not supplied with the motherboard. The chassis manufacturer should supply these parts.

Step	Action
1	Place the chassis on an anti-static mat. Connect the chassis to ground to avoid static damage during installation. Connect an alligator clip with a wire lead to any unpainted part of the chassis. Ground the other end of the lead at the same point as the mat and the wristband.
2	Rotate the chassis so the front is to the right, and the rear is to the left. The side facing you is where the motherboard is mounted. The power supply is mounted at the far end of the chassis.
3	Hold the motherboard, component-side up, with the edge with the SIMM sockets toward you and the edge with the power supply connector away from you. The keyboard, mouse, and video connectors should be to the left.
4	Carefully slide the motherboard into the chassis. Make certain the edge connectors fit the ports in the rear of the chassis. The motherboard should rest level with the chassis.
5	Place the mounting screws in the holes provided and tighten them. If necessary, shift the motherboard slightly to align the mounting holes on the motherboard with the holes on the chassis. See the drawing on the next page.



Warning

If using metallic screws, make sure you use them only in the plated mounting holes.

If using metallic screws, make sure the head of the screw fits completely inside the plated mounting holes.

Step 5 Attach Cables

Connectors The Atlas PCI-III motherboard connectors are:

Connector	Turn to
J18 Clear password	page 21
J19 IRQ12 Use	page 23
P7 and P6 Power supply connectors	page 21
Keyboard connector	page 22
Mouse connectors	page 23
J13 CPU Fan	page 24
USB1 and USB2 USB connectors	page 24
J23 Speaker	page 25
J20 IDE LED	page 25
J21 Hardware Reset Switch	page 25
J22 External SMI Connector	page 25
J24 Keyboard Lock	page 25
P1 and P2 Serial Port Connectors	page 28
P4 Parallel port connector	page 28
P3 Floppy drive connector	page 29
P4 and P9 IDE drive connectors	page 32

Cable Connector Ends When connecting chassis connectors to the motherboard, make sure to connect the correct connector end. Most connector wires are color-coded. Match the color of the wires leaving the switch or LED to the same pin on the connector end. There may be more than one connector with the same color-coded wires. If so, follow the wire to the switch or LED. Pin 1 is indicated for all motherboard components by a white line. Pin 1 is always nearest to the white line.

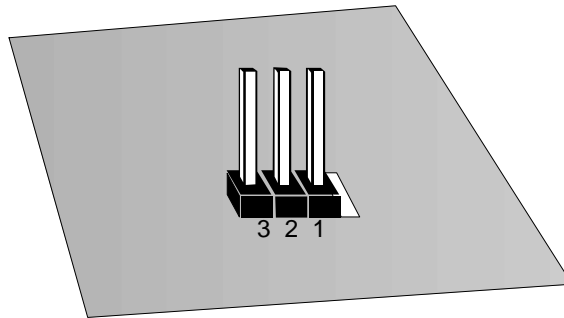

Cont'd

Step 5 Attach Cables, Continued

J18 Clear Password If you forget the computer password, the only course of action is to erase the system configuration information stored in the NVRAM (Non-Volatile Random Access Memory). The computer password is stored in the system configuration data. Short the J18 pins together for two seconds. All system memory will be erased. You must now turn the computer power on and run WINBIOS Setup to reset all system configuration information. *Make sure that J18 remains OPEN unless you have to erase a forgotten password.*

Connect Power Supply The power supply should match the physical configuration of the chassis. Make sure that the power switch is Off before assembly. Before attaching all components, make sure that the proper voltage has been selected. Power supplies often can run on a wide range of voltages and must be set (usually via a switch) to the proper range. Use at least a 400 watt power supply, which should have built-in filters to suppress radiated emissions.

Power Cables Attach the power cables to the P6 and P7 power connectors on the motherboard. AT-compatible power supplies have two 6-pin connectors:

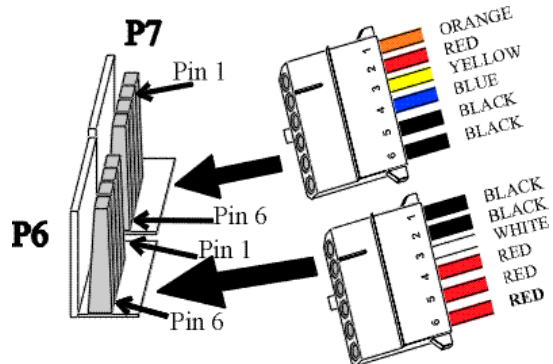

Power Supply Connectors

Cont'd

Step 5 Attach Cables, Continued

Connector Keys The keys on the connector must be cut to fit on some power supplies, as shown below.

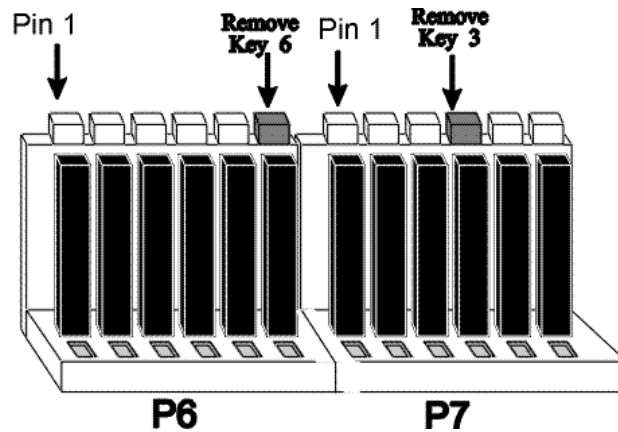

P6 Power Connector Pinout

Pin	Description
1	Ground (Black wire)
2	Ground (Black wire)
3	-5 Volts (White wire)
4	VCC (Red wire)
5	VCC (Red wire)
6	VCC (Red wire)

P7 Power Connector Pinout

Pin	Description
1	Power Good (Orange wire) (Not used)
2	VCC (Red wire)
3	+12 Volts (Yellow wire)
4	-12 Volts (Blue wire)
5	Ground (Black wire)
6	Ground (Black wire)

Cont'd

Step 5 Attach Cables, Continued

Keyboard Cable The keyboard attaches via a PS/2 keyboard connector, labeled KB_CONN.

Pin	Assignments
1	Keyboard data
2	N/C
3	Ground
4	VCC
5	Keyboard clock
6	N/C

10-Pin Mouse Connector Attach the mouse connector cable supplied by American Megatrends to the 10-pin mouse berg connector on the motherboard, as shown below. Attach the standard 9-pin mouse connector at the other end of the mouse cable to the mouse connector port on the computer case. Incorrect mouse installation can cause the system to hang.

Pin	Description
1	Mouse Clock
2	N/C
3	N/C
4	Mouse Data
5	Ground

Cont'd

Step 5 Attach Cables, Continued

When attaching connectors to the motherboard, make sure to connect the correct connector end. Most connector wires are color-coded. Match the color of the wires leaving the switch or LED to the same pin on the connector end. There may be more than one connector with the same color-coded wires. If so, follow the wire to the switch or LED. Pin 1 is always indicated on the motherboard.

J13 CPU Fan A 2-pin berg labeled J13 attaches to the CPU fan. The J13 connector is next to the CPU socket.

Pin	Description
1	+12V
2	Ground

J22 External SMI Connector Attach the 2-wire cable from the external SMI source to J22. J22 is a 2-pin berg.

USB Connectors The motherboard has two 4-pin headers that attach to a USB connector on the computer chassis. The USB port allows you to attach to a USB hub. The pinouts are the same for both USB connectors:

Pin	Signal Description
1	VCC (Fused 5V)
2	- Data
3	+ Data
4	Ground

Cont'd

Step 5 Attach Cables, Continued

PS/2 Mouse IRQ J19 is a three-pin berg that enables the PS/2 mouse interrupt (IRQ12). Short Pins 2-3 of J19 to enable IRQ12 as the PS/2 mouse interrupt. You should always short Pins 2-3 to enable the PS/2 mouse interrupt. The only reason you would ever have to short Pins 1-2 is if you wanted an adapter card on the ISA bus to use IRQ12. You would then have to set the **Mouse Support** option in Advanced Setup to *Disabled*.

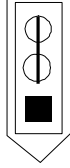

J19 Pins 2-3 Shorted
IRQ12 used for PS/2 Mouse

J21 Reset Switch Connector J21 is a two-pin single-inline berg that is attached via a cable to an externally-mounted reset switch.

When the reset switch is pressed, the system performs a hard reset. Pin 1 is ground and Pin 2 is Hard Reset.

J23 Speaker Connector J23 is a four-pin single-inline berg that is optionally attached via a cable to a standard system speaker. AMIBIOS signals hardware problems through the speaker. Pin 1 on the motherboard is identified by the arrow on the white box around the berg. The motherboard also has a built-in speaker mounted on the motherboard.

Pin	Description
1	Data Out
2	Key
3	N/C
4	VCC

Cont'd

Step 5 Attach Cables, Continued

J24 Keyboard Lock J24 is a 5-pin single-inline berg that is attached via a cable to the keyboard lock connector (or separate keyboard lock and Power LED connectors). The computer chassis may not include the keyboard lock and Power LED on a single connector. The keyboard lock allows the user to lock the keyboard, protecting the system from unauthorized use. Pin 1 on the motherboard is identified by the broad arrow.

Pin	Description
1	VCC
2	Ground
3	Ground
4	Keyboard Lock (KBDINH)
5	Ground

J20 IDE LED J20 is a two-pin berg that is attached via a cable to the externally-mounted IDE Activity LED. This LED lights when the IDE drive is running.

	<p>Warning</p> <p>In some IDE drives, you may have to disable the IDE LED mounted on the drive by changing a jumper or setting a switch on the IDE drive itself, before the IDE drive sends a signal to J34.</p>
---	---

Step 6 Onboard I/O

Onboard I/O The Atlas PCI-III motherboard has:

- two serial ports (P1 and P2),
- a parallel port (P4),
- an IDE controller on the PCI bus. The primary IDE connector is P5. The secondary connector is P9.
- a floppy controller (P3).

The serial and parallel port connectors are described below. The floppy connector is described on page 29. The IDE connector is described on page 30.

Conflicts AMIBIOS minimizes conflicts between onboard and offboard I/O devices.

AMIBIOS automatically checks the adapter cards installed in the expansion slots on the Atlas PCI-III motherboard for a hard disk or floppy controller and serial or parallel ports.

Serial Ports P1 and P2 are 10-pin connectors that provide an AT-compatible serial port interface. Connect the cables supplied with the motherboard to the 10-pin serial connectors. The serial port base I/O port address and other serial port settings can be selected in Peripheral Setup in WINBIOS Setup. The serial connector pinout is shown below.

Pin	Signal Description	Pin	Signal Description
1	Carrier Detect	6	Data Set Ready
2	Receive Data	7	Request to Send
3	Transmit Data	8	Clear to Send
4	Data Terminal Ready	9	Ring Indicator
5	Ground	10	CUT PIN

Cont'd

Step 6 Onboard I/O, Continued

Parallel Port P4 is a 26-pin connector for a parallel port. The LPT pinout is shown below. Connect the 26-pin to DB25 cable provided with the motherboard to P4. All parallel port settings can be configured through Peripheral Setup in WINBIOS Setup.

Pin	Signal Description	Pin	Signal Description
1	STROBE#	2	PD0
3	PD1	4	PD2
5	PD3	6	PD4
7	PD5	8	PD6
9	PD7	10	ACK#
11	BUSY	12	PE
13	SLCT	14	AUTOFD#
15	ERROR#	16	INIT#
17	SLCTIN#	18	Ground
19	Ground	20	Ground
21	Ground	22	Ground
23	Ground	24	Ground
25	Ground	26	Ground

Step 7 Attach Floppy Drive

P3 is a 34-pin dual-inline berg. Connect the cable from the floppy drive to FDD, as shown below. The onboard floppy controller cannot be used if a hard disk card with a floppy controller is installed. Choose Standard Setup and Peripheral Setup to configure the floppy controller.

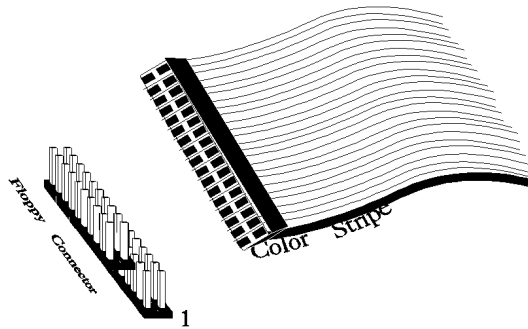

The motherboard supports up to two 720 KB, 1.44 MB, or 2.88 MB 3½" drives and 360 KB and 1.2 MB 5¼" drives. The connecting cable is a 34-pin ribbon connector with two 34-pin edge connectors for attaching the floppy disk drives. There is a small twist in the cable between the floppy connectors. The last (end) connector should be connected to floppy drive A:.

Cont'd

Step 7 Attach Floppy Drive, Continued

Floppy Connector Pinout

Pin	Signal Description	Pin	Signal Description
1	GND	2	DENSE1
3	GND	4	N/C
5	GND	6	DRATE0
7	GND	8	-INDEX
9	GND	10	-MOTOR0
11	GND	12	-FDSEL1
13	GND	14	-FDSEL0
15	GND	16	-MOTOR1
17	GND	18	DIR
19	GND	20	-
21	GND	22	-WDATA
23	GND	24	-WGATE
25	GND	26	-TRK0
27	GND	28	-WRPROT
29	GND	30	-RDATA
31	GND	32	HDSEL
33	GND	34	DSKCHNG

Twist in Floppy Cable

Floppy B to A	Floppy B to A	Floppy B to A	Floppy B to A
10 to 16	12 to 14	14 to 12	16 to 10
11 to 15	13 to 13	15 to 11	

Step 8 Attach IDE Drive

IDE Drives

Attach the IDE drives in the following manner. Choose Peripheral Setup in WINBIOS Setup to enable the onboard IDE controller.

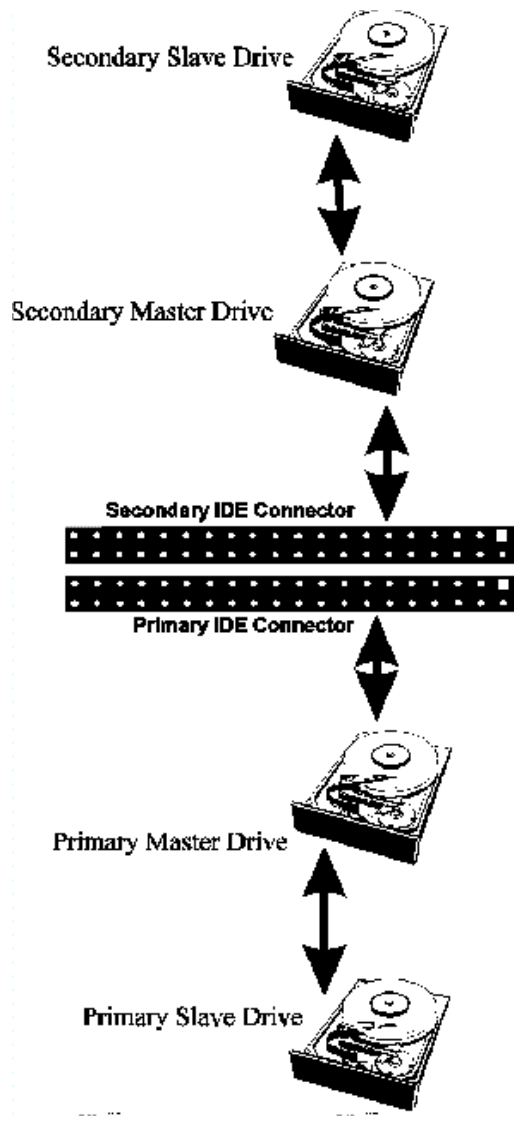

Cont'd

Step 8 Attach IDE Drive, Continued

Attach IDE Cable P5 is the primary IDE (Integrated Drive Electronics) hard disk drive connector. Both the primary master and the primary slave IDE drives must be connected by cable to P5, as shown below.

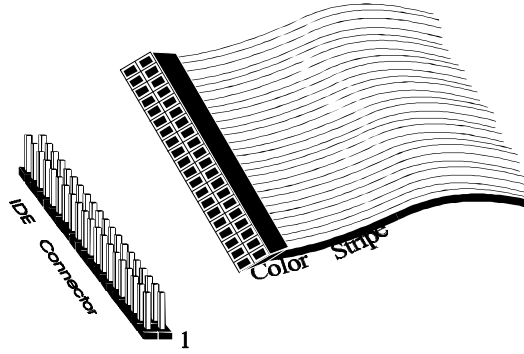

P5 is a 40-pin dual-inline berg that connects an IDE drive to the primary onboard IDE connector. This motherboard supports IDE Modes 0, 1, 2, 3, and 4, IDE prefetch, LBA (Logical Block Address) mode, high capacity drives (over 528 MB), 32-bit data transfer, and fast IDE transfer. These IDE features are configured in Peripheral Setup in the WINBIOS Setup utility. Disable the onboard IDE interface in Peripheral Setup to use an ISA ESDI, RLL, MFM, or SCSI hard disk drive controller.

Cont'd

Step 8 Attach IDE Drive, Continued

P5 Pinout

The P5 pinout is:

Pin	Signal Description	Pin	Signal Description
1	-RESET	2	GND
3	DATA7	4	DATA8
5	DATA6	6	DATA9
7	DATA5	8	DATA10
9	DATA4	10	DATA11
11	DATA3	12	DATA12
13	DATA2	14	DATA13
15	DATA1	16	DATA14
17	DATA0	18	DATA15
19	GND	20	KEY (N/C)
21	N/C	22	GND
23	-IOW	24	GND
25	-IOR	26	GND
27	IDERDY	28	ALE
29	N/C	30	GND
31	INT14	32	-IOCS16
33	HA1	34	N/C
35	HA0	36	HA2
37	-CS0	38	-CS1
39	-IDEACT	40	GND

P9 Secondary IDE Controller P9, the secondary IDE connector, is a 40-pin dual-inline berg that connects the secondary primary and slave IDE drives to the secondary onboard IDE controller.

Attach the secondary master and slave IDE drives to IDE2 via a standard 40-pin IDE cable as shown on page 32.

Cont'd

Step 8 Attach IDE Drive, Continued

P9 Pinout

The P9 pinout is:

Pin	Signal Description	Pin	Signal Description
1	-RESET	2	GND
3	DATA7	4	DATA8
5	DATA6	6	DATA9
7	DATA5	8	DATA10
9	DATA4	10	DATA11
11	DATA3	12	DATA12
13	DATA2	14	DATA13
15	DATA1	16	DATA14
17	DATA0	18	DATA15
19	GND	20	KEY (N/C)
21	N/C	22	GND
23	-IOW	24	GND
25	-IOR	26	GND
27	IDERDY	28	ALE
29	N/C	30	GND
31	INT15	32	-IOCS16
33	HA1	34	N/C
35	HA0	36	HA2
37	-CS2	38	-CS3
39	N/C	40	GND

Step 9 Test and Configure

Review the following points before powering up:

- make sure that all adapter cards are seated properly,
 - make sure all connectors are properly installed,
 - make sure the CPU is seated properly,
 - make sure there are no screws or other foreign material on the motherboard,
 - plug the system into a surge-protected power strip, and
 - make sure blank back panels are installed on the back of the chassis to minimize RF emissions.
-

Start the Test Plug everything in and turn on the switch. If there are any signs of a problem, turn off the unit immediately. Reinstall the connectors. Call Technical Support if there are problems.

BIOS Errors If the system operates normally, a display should appear on the monitor. The BIOS Power On Self Test (POST) should execute.

If POST does not run successfully, it will beep or display error messages. Beeps indicate a serious problem with the system configuration or hardware. The Beep Code indicates the problem. AMIBIOS Beep Codes are defined in *the AMIBIOS Technical Reference*. Make sure the affected part is properly seated and connected. An error message is displayed if the error is less serious. Recheck the system configuration or the connections.

Configure the System Run WINBIOS Setup. You must enter the requested information and save the configuration data in CMOS RAM. The system will then reset, run POST, and boot the operating system. See the following chapter for information about configuring the computer.

2 WINBIOS[®] Setup

In ISA and EISA computers, the system parameters (such as amount of memory, type of disk drives and video displays, and many other elements) are stored in CMOS RAM. Unlike the DRAM (dynamic random access memory) that is used for standard system memory, CMOS RAM requires very little power. When the computer is turned off, a back-up battery provides power to CMOS RAM, which retains the system parameters. Every time the computer is powered-on, the computer is configured with the values stored in CMOS RAM by the system BIOS, which gains control when the computer is powered on.

The system parameters are configured by a system BIOS Setup utility. Historically, BIOS Setup utilities have been character-based, required keyboard input, and have had user interfaces that were not very intuitive.

Graphical Interface American Megatrends has a new type of system BIOS Setup utility.

WINBIOS Setup has a graphical user interface the end user can access using a mouse. The WINBIOS Setup code is so compact that it can reside on the same ROM as the system BIOS. The system configuration parameters are set by WINBIOS Setup.

Since WINBIOS Setup resides in the ROM BIOS, it is available each time the computer is turned on.

Starting WINBIOS Setup As POST executes, the following appears:

```
Hit <DEL> if you want to run SETUP
```

```
Press <Del> to run WINBIOS Setup.
```

Using a Mouse with WINBIOS Setup

WINBIOS Setup has a built-in mouse driver and can be accessed by either a serial mouse or PS/2-style mouse. WINBIOS Setup supports Microsoft-Compatible serial mice and all PS/2-type mice.

The mouse click functions are: single click to change or select both global and current fields and double click to perform an operation in the selected field.

Using the Keyboard with WINBIOS Setup

WINBIOS has a built-in keyboard driver that uses simple keystroke combinations:

Keystroke	Action
<Tab>	Change or select a global field.
<→, ←, ↑, ↓>	Change or select the current field.
<Enter>	Perform an operation in the current field.
+	Increment a value.
-	Decrement a value.
<Esc>	Abort any window function.
<PgUp>	Return to the previous screen.
<PgDn>	Advance to the next screen.
<Home>	Returns to the beginning of the text.
<End>	Advance to the end of the text.
<Ctrl><Alt><+>	Change to high speed.
<Ctrl><Alt><->	Change to low speed.

WINBIOS Setup Menu

The WINBIOS Setup main menu is organized into four sections. Each of these sections corresponds to a section in this chapter.

Each section contains several icons. Clicking on each icon activates a specific AMIBIOS function. The WINBIOS Setup main windows and related functions are described on the next page.

Main Windows The WINBIOS Setup main windows are:

- Setup, described in Section 1 on page 40, has icons that permit you to set system configuration options such as date, time, hard disk type, floppy type, and many others,
 - Security, described in Section 2 beginning on page 61, has three icons that control AMIBIOS security features, and
 - Utilities, described in Section 3 beginning on page 64, sets the screen color and allows language changes,
 - Default, described in Section 4 beginning on page 64, this section has three icons that permit you to select a group of settings for all WINBIOS Setup options.
-

Section 1 Setup

Standard Setup

Standard Setup options are displayed by choosing the Standard icon from the WINBIOS Setup main menu. All Standard Setup options are described in this section.

Date/Time Select the Standard option. Select the Date and Time icon. The current values for each category are displayed. Enter new values through the keyboard.

Floppy Drive A: and B: Move the cursor to these fields via ↑ and ↓ and select the floppy type. The settings are *360 KB 5¼ inch*, *1.2 MB 5¼ inch*, *720 KB 3½ inch*, *1.44 MB 3½ inch*, or *2.88 MB 3½ inch*.

Primary Master, Primary Slave, Secondary Master, Secondary Slave Select one of these hard disk drive icons to configure the hard disk drive named in the option. Select *Auto* from the drive parameters screen to let AMIBIOS automatically configure the drive. A screen with a list of drive parameters appears. Click on *OK* to configure the drive.

Drive Type	How to Configure
SCSI	Select <i>Type</i> . Select <i>Not Installed</i> in the drive parameter screen. The SCSI drivers provided by the SCSI drive or SCSI host adapter manufacturer should allow you to configure the SCSI drive.
IDE	Select <i>Type</i> . Select <i>Auto</i> to let AMIBIOS determine the parameters. Click on <i>OK</i> when AMIBIOS displays the drive parameters. Select <i>LBA/Large Mode</i> . Select <i>On</i> if the drive has a capacity greater than 540 MB. Select <i>Block Mode</i> . Select <i>On</i> to allow block mode data transfers. Select <i>32-Bit Transfer</i> . Select <i>On</i> to allow 32-bit data transfers. Select the <i>PIO Mode</i> . It is best to select <i>Auto</i> to allow AMIBIOS to determine the PIO mode. If you select a PIO mode that is not supported by the IDE drive, the drive will not work properly. If you are absolutely certain that you know the drive's PIO mode, select PIO mode 0 - 5, as appropriate.
CD-ROM	Select <i>Type</i> . Select <i>CDROM</i> . Click on <i>OK</i> when AMIBIOS displays the drive parameters.
Standard MFM Drive	Select <i>Type</i> . You must know the drive parameters. Select the drive type that exactly matches your drive's parameters.
Non-Standard MFM Drive	Select <i>Type</i> . If the drive parameters do not match the drive parameters listed for drive types 1 - 46, select <i>User</i> and enter the correct hard disk drive parameters.

Cont'd

Standard Setup, Continued

Entering Drive Parameters You can also enter the hard disk drive parameters. The drive parameters are:

Parameter	Description
Type	The number for a drive with certain identification parameters.
Cylinders	The number of cylinders in the disk drive.
Heads	The number of heads.
Write Precompensation	The actual physical size of a sector gets progressively smaller as the track diameter diminishes. Yet each sector must still hold 512 bytes. Write precompensation circuitry on the hard disk compensates for the physical difference in sector size by boosting the write current for sectors on inner tracks. This parameter is the track number on the disk surface where write precompensation begins.
Landing Zone	This number is the cylinder location where the heads normally park when the system is shut down.
Sectors	The number of sectors per track. MFM drives have 17 sectors per track. RLL drives have 26 sectors per track. ESDI drives have 34 sectors per track. SCSI and IDE drives have even more sectors per track.
Capacity	The formatted capacity of the drive is the number of heads times the number of cylinders times the number of sectors per track times 512 (bytes per sector).

Cont'd

Standard Setup, Continued

Hard Disk Drive Types

Type	Cylinders	Heads	Write Precompensation	Landing Zone	Sectors	Capacity
1	306	4	128	305	17	10 MB
2	615	4	300	615	17	20 MB
3	615	6	300	615	17	31 MB
4	940	8	512	940	17	62 MB
5	940	6	512	940	17	47 MB
6	615	4	65535	615	17	20 MB
7	462	8	256	511	17	31 MB
8	733	5	65535	733	17	30 MB
9	900	15	65535	901	17	112 MB
10	820	3	65535	820	17	20 MB
11	855	5	65535	855	17	35 MB
12	855	7	65535	855	17	50 MB
13	306	8	128	319	17	20 MB
14	733	7	65535	733	17	43 MB
16	612	4	0	663	17	20 MB
17	977	5	300	977	17	41 MB
18	977	7	65535	977	17	57 MB
19	1024	7	512	1023	17	60 MB
20	733	5	300	732	17	30 MB
21	733	7	300	732	17	43 MB
22	733	5	300	733	17	30 MB
23	306	4	0	336	17	10 MB
24	925	7	0	925	17	54 MB
25	925	9	65535	925	17	69 MB
26	754	7	754	754	17	44 MB
27	754	11	65535	754	17	69 MB
28	699	7	256	699	17	41 MB
29	823	10	65535	823	17	68 MB
30	918	7	918	918	17	53 MB
31	1024	11	65535	1024	17	94 MB
32	1024	15	65535	1024	17	128 MB
33	1024	5	1024	1024	17	43 MB
34	612	2	128	612	17	10 MB
35	1024	9	65535	1024	17	77 MB
36	1024	8	512	1024	17	68 MB
37	615	8	128	615	17	41 MB
38	987	3	987	987	17	25 MB
39	987	7	987	987	17	57 MB
40	820	6	820	820	17	41 MB
41	977	5	977	977	17	41 MB
42	981	5	981	981	17	41 MB
43	830	7	512	830	17	48 MB
44	830	10	65535	830	17	69 MB
45	917	15	65535	918	17	114 MB
46	1224	15	65535	1223	17	152 MB
AMIBIOS automatically sets IDE drive parameters. Select USER to enter MFM, ESDI, or RLL drive parameters. Select Not Installed for SCSI drives. Select CDROM for CD-ROM drives.						

Advanced Setup

Advanced Setup options are displayed by choosing the Advanced icon from the WINBIOS Setup main menu. All Advanced Setup options are described in this section.

System Keyboard This option does not specify if a keyboard is attached to the computer. Rather, it specifies if error messages are displayed if a keyboard is not attached. This option permits you to configure workstations with no keyboards. The settings are *Absent* or *Present*. The Optimal and Fail-Safe default settings are *Present*.

Primary Display This option configures the type of monitor attached to the computer. The settings are *Mono*, *CGA40x25*, *CGA80x25*, *VGA/EGA*, or *Absent*. The Optimal and Fail-Safe default settings are *VGA/EGA*.

PS/2Mouse Support Set this option to *Enabled* to enable AMIBIOS support for a PS/2-type mouse.. The settings are *Enabled* or *Disabled*. The Optimal and Fail-Safe default settings are *Enabled*.

Pause on Config. Screen This option specifies the length of time that the AMIBIOS configuration screen appears. The settings are 2 (*seconds*), 3, 4, 5, 6, 7, 8, 9, 10, 11, 12, 13, 14, or *Disabled*. The Optimal and Fail-Safe default settings are *Disabled*.

Cont'd

Advanced Setup, Continued

Boot Up Num Lock Set this option to *On* to turn the Num Lock key On at system boot. The settings are *On* or *Off*. The Optimal and Fail-Safe default settings are *On*.

Password Check This option enables the password check option every time the system boots or the end user runs Setup. If *Always* is chosen, a user password prompt appears every time the computer is turned on. If *Setup* is chosen, the password prompt appears if WINBIOS is executed. See page 61 for instructions on changing a password. The Optimal and Power-On defaults are *Setup*.

Boot To OS/2 Set this option to *Yes* if running OS/2 operating system and using more than 64 MB of system memory on the motherboard. The settings are *Yes* or *No*. The Optimal and Fail-Safe default settings are *No*.

Floppy Drive Swap Set this option to *Enabled* to permit drives A: and B: to be swapped. The settings are *Enabled* or *Disabled*. The Optimal and Fail-Safe default settings are *Disabled*.

Boot Up Sequence This option sets the sequence of boot drives (either floppy drive A, hard disk drive C:, or a CD-ROM drive.) AMIBIOS attempts to boot from after AMIBIOS POST completes. The three settings are *C:,A:,CDROM*, *A:,C:CDROM*, and *CDROM,C:,A:*. The Optimal default setting is *C:,A:CDROM*. The Fail-Safe default setting is *A:,C:CDROM*.

Cont'd

Advanced Setup, Continued

External Cache Set this option to *Enabled* to enable L2 secondary (external) cache memory. The settings are *Enabled* or *Disabled*. The Optimal default setting is *Enabled*. The Fail-Safe default setting is *Disabled*.

Caching Controller Set this option to *Yes* if a cache controller is installed in the computer.

Setting	Description
<i>Absent</i> (the default setting)	To comply with the PCI specifications, PCI adapter cards must be reset every time the CPU is reset. When the end user forces a soft reset by pressing <Ctrl> <Alt> , only the CPU is reset. When this option is set to No, all soft resets are converted to hard resets, and all PCI adapter cards are reset when the CPU is reset.
<i>Present</i>	Soft resets still behave like soft resets when Yes is selected. Select this option if a caching controller is installed in the computer. Soft resets must not generate a hard reset if a caching controller is used. If a hard reset is generated, a PCI caching controller card cannot flush data from cache memory to a hard disk drive before the reset.

Video Shadow C000,32K This option controls the location of the contents of video ROM. The settings are:

Setting	Description
<i>Shadow</i>	The contents of the video ROM area (C0000h - C7FFFh) are written to the corresponding address in RAM.
<i>Cached</i>	The contents of the video ROM area (C0000h - C7FFFh) are written to the corresponding RAM address and may be read from or written to cache memory.
<i>Disabled</i>	The video ROM is not copied to RAM. The contents of the video ROM cannot be read from or written to cache memory.

The Optimal default setting is *Cached*. The Fail-Safe default setting is *Disabled*.

Cont'd

Advanced Setup, Continued

Shadow C800,16K

Shadow CC00,16K

Shadow D000,16K

Shadow D400,16K

Shadow D800,16K

Shadow DC00,16K These options enable shadowing of the contents of the ROM area in the option title.

Setting	Description
<i>Shadow</i>	The contents of the ROM area are written to the corresponding address in RAM for faster execution.
<i>Cached</i>	The contents of the ROM area are written to the corresponding RAM address and can be read from or written to cache memory.
<i>Disabled</i>	The ROM is not copied to RAM. The contents of the video ROM cannot be read from or written to cache memory.

The Optimal and Fail-Safe settings are *Disabled*.

Chipset Setup

Memory Hole This option allows the end user to specify a memory hole. The settings are *Disabled*, *512-640K*, or *15-16M* (from 15 MB to 16 MB). The Optimal and Fail-Safe default settings are *Disabled*.

IRQ12/M Mouse Function This option should be set according to the mouse hardware implementation. The Optimal and Fail-Safe default settings are *Enabled*. The settings are:

Settings	Description
<i>Disabled</i>	Choose this setting if the hardware uses IRQ12 for the PS/2 mouse.
<i>Enabled</i>	Choose this setting if a keyboard controller mouse interrupt is used for the mouse.

DRAM Data Integrity Mode This option sets the system memory integrity mode. The settings are *Parity* (*system memory parity is checked*) or *ECC* (*an Error Checking and Correction routine is used*). The Optimal and Fail-Safe default settings are *Parity*.

USB Function Set this option to *Enabled* to enable the system BIOS USB (Universal Serial Bus) functions. The settings are *Enabled* or *Disabled*. The Optimal and Fail-Safe default settings are *Enabled*.

USB Keyboard/Mouse Legacy Support Set this option to *Enabled* to enable USB support for legacy keyboards and mice. The settings are *Enabled* or *Disabled*. The Optimal and Fail-Safe default settings are *Enabled*.

Power Management Setup

The AMIBIOS Setup options described in this section are selected by choosing the Power Management Setup icon from the Setup section on the AMIBIOS Setup main menu.

Power Management/APM Set this option to *Enabled* to enable the Intel Triton 2 power management features and APM (Advanced Power Management). The settings are *Enabled*, *Inst-On (instant-on)*, or *Disabled*. The Optimal and Fail-Safe default settings are *Disabled*.

Instant-On Timeout (Minute) This option specifies the length of a period of system inactivity while the computer is in Full power on state. When this length of time expires, AMIBIOS takes the computer to a lower power consumption state, but the computer can return to full power instantly when any system activity occurs. *This option is only available if supported by the computer hardware.* The settings are *Disabled* and *1 Min.* through *15 Min* in 1 minute intervals. The Optimal and Fail-Safe default settings are *Disabled*.

Green PC Monitor Power State This option specifies the power state that the green PC-compliant video monitor enters when AMIBIOS places it in a power saving state after the specified period of display inactivity has expired. The settings are *Off*, *Standby*, *Suspend*, or *Disabled*. The Optimal and Fail-Safe default settings are *Standby*.

Video Power Down Mode This option specifies the power conserving state that the VESA VGA video subsystem enters after the specified period of display inactivity has expired. The settings are *Disabled*, *Standby*, or *Suspend*. The Optimal and Fail-Safe default settings are *Disabled*.

Cont'd

Power Management Setup, Continued

Hard Disk Power Down Mode This option specifies the power conserving state that the hard disk drive enters after the specified period of hard drive inactivity has expired. The settings are *Disabled*, *Standby*, or *Suspend*. The Optimal and Fail-Safe default settings are *Disabled*.

Hard Disk Timeout (Minute) This option specifies the length of a period of hard disk drive inactivity. When this length of time expires, the computer enters power-conserving state specified in the **Hard Disk Power Down Mode** option (see the previous page). The settings are *Disabled* and *1 Min.* through *15 Min* in 1 minute intervals. The Optimal and Fail-Safe default settings are *Disabled*.

Standby Timeout (Minute) This option specifies the length of a period of system inactivity while in Full power on state. When this length of time expires, the computer enters Standby power state. The settings are *Disabled* and *1 Min.* through *15 Min* in 1 minute intervals. The Optimal and Fail-Safe default settings are *Disabled*.

Suspend Timeout (Minute) This option specifies the length of a period of system inactivity while in Standby state. When this length of time expires, the computer enters Suspend power state. The settings are *Disabled* and *1 Min.* through *15 Min* in 1 minute intervals. The Optimal and Fail-Safe default settings are *Disabled*.

Cont'd

Power Management Setup, Continued

Slow Clock Ratio This option specifies the speed at which the system clock runs in power saving states. The settings are expressed as a ratio between the normal CPU clock speed and the CPU clock speed when the computer is in the power-conserving state. The settings are *1:1*, *1:2*, *1:4*, *1:8*, *1:16*, *1:32*, *1:64*, and *1:128*. The Optimal and Fail-Safe defaults are *1:8*.

Display Activity This option specifies if AMIBIOS is to monitor display activity for power conservation purposes. When this option is set to *Monitor* and there is no display activity for the length of time specified in the **Standby Timeout (Minutes)** option, the computer enters a power savings state. The settings are *Monitor* or *Ignore*. The Optimal and Fail-Safe default settings are *Ignore*.

Cont'd

IRQ3
IRQ4
IRQ5
IRQ7
IRQ9
IRQ10
IRQ11
IRQ12
IRQ13
IRQ14
IRQ15

When set to *Monitor*, these options enable event monitoring on the specified IRQ line. If set to *Monitor* and the computer is in a power saving state, AMIBIOS watches for activity on the specified IRQ line. The computer enters the full on power state if any activity occurs. AMIBIOS reloads the Standby and Suspend timeout timers if activity occurs on the specified IRQ line. The settings for each of these options are *Ignore*, or *Monitor*. The defaults are:

Option	Optimal	Fail-Safe
IRQ3	Ignore	Ignore
IRQ4	Ignore	Ignore
IRQ5	Ignore	Ignore
IRQ7	Ignore	Ignore
IRQ9	Ignore	Ignore
IRQ10	Ignore	Ignore
IRQ11	Ignore	Ignore
IRQ12	Monitor	Ignore
IRQ13	Ignore	Ignore
IRQ14	Monitor	Ignore
IRQ15	Ignore	Ignore

PCI/PnP Setup

Choose the PCI/PnP Setup icon from the WINBIOS Setup screen to display the PCI and Plug and Play Setup options, described below.

Plug and Play-Aware OS Set this option to *Yes* if the operating system in this computer is aware of and follows the Plug and Play specification. Windows 95 is PnP-aware. The settings are *Yes* or *No*. The Optimal and Fail-Safe default settings are *No*.

Allocate IRQ to PCI VGA Set this option to *Yes* to allocate an IRQ to a VGA adapter card that uses the PCI local bus. The settings are *Yes* or *No*. The Optimal and Fail-Safe default settings are *Yes*.

PCI Slot-1 Latency Timer

PCI Slot-2 Latency Timer

PCI Slot-3 Latency Timer

PCI Slot-4 Latency Timer These options specify the latency timings (in PCI clocks) for PCI devices installed in the four PCI expansion slots. The settings are 32, 64, 96, 128, 160, 192, 224, or 248. The Optimal and Fail-Safe default settings are 64.

USB Device Latency Timer This option specifies the latency timings (in PCI clocks) for USB devices installed in the computer. The settings are 32, 64, 96, 128, 160, 192, 224, or 248. The Optimal and Fail-Safe default settings are 64.

USB Device IRQ Preference These options specify the IRQ priority for USB devices installed in the computer. The settings are *Auto*, *IRQ5*, *IRQ9*, *IRQ10*, *IRQ11*, *IRQ14*, and *IRQ15*, in priority order. If *Auto* is selected, AMIBIOS automatically determines the optimal IRQ priority order. The Optimal and Fail-Safe default settings are *Auto*.

Cont'd

PCI Slot-1 IRQ Preference

PCI Slot-2 IRQ Preference

PCI Slot-3 IRQ Preference

PCI Slot-4 IRQ Preference These options specify the IRQ priority for PCI devices installed in the four PCI expansion slots. The settings are *Auto*, *IRQ5*, *IRQ9*, *IRQ10*, *IRQ11*, *IRQ 14*, and *IRQ15*, in priority order. If *Auto* is selected, AMIBIOS automatically determines the optimal IRQ priority order. The Optimal and Fail-Safe default settings are *Auto*.

Cont'd

IRQ3
 IRQ4
 IRQ5
 IRQ7
 IRQ9
 IRQ10
 IRQ11
 IRQ12
 IRQ14
 IRQ15

These options specify the bus that the specified IRQ line is used on. These options allow you to reserve IRQs for legacy ISA adapter cards. These options determine if AMIBIOS should remove an IRQ from the pool of available IRQs passed to devices that are configurable by the system BIOS. The available IRQ pool is determined by reading the ESCD NVRAM. If more IRQs must be removed from the pool, the end user can use these options to reserve the IRQ by assigning an *ISA* setting to it. Onboard I/O is configured by AMIBIOS. All IRQs used by onboard I/O are configured as *PCI*, *PnP*, or *PCI/PnP*. IRQ14 and 15 will not be available if the onboard Triton 2 PCI IDE is enabled. If all IRQs are set to *ISA* and IRQ14 and 15 are allocated to the onboard PCI IDE, IRQ9 will still be available for PCI and PnP devices, because at least one IRQ must be available for PCI and PnP devices. The settings are *ISA*, *PnP*, *PCI/PnP*, or *PCI*. The Optimal and Fail-Safe default settings are:

Option	Optimal Default	Fail-Safe Default
IRQ3	PnP	PCI/PnP
IRQ4	PnP	PCI/PnP
IRQ5	PCI/PnP	PCI/PnP
IRQ7	PnP	PCI/PnP
IRQ9	PCI/PnP	PCI/PnP
IRQ10	PCI/PnP	PCI/PnP
IRQ11	PCI/PnP	PCI/PnP
IRQ12	PnP	PnP
IRQ14	PCI/PnP	PCI/PnP
IRQ15	PCI/PnP	PCI/PnP

Cont'd

DMA Channel 0

DMA Channel 1

DMA Channel 3

DMA Channel 5

DMA Channel 6

DMA Channel 7 These options allow you to specify the bus type used by each DMA channel. The settings are *PnP* or *ISA*. The Optimal and Fail-Safe default settings are *PnP*.

Reserved ISA Card Memory Size This option specifies the size of the memory area reserved for legacy ISA adapter cards. The settings are *Disabled*, *16K*, *32K*, or *64K*. The Optimal and Fail-Safe default settings are *Disabled*.

Reserved ISA Card Memory Address This option specifies the beginning address (in hex) of the reserved memory area. The specified ROM memory area is reserved for use by legacy ISA adapter cards.

The settings are *C0000*, *C4000*, *C8000*, *CC000*, *D0000*, *D4000*, *D8000*, or *DC000*. The Optimal and Fail-Safe default settings are *C4000*.

Peripheral Setup

Choose the Peripheral Setup icon from the WINBIOS Setup screen to display the Peripheral Setup options, described below.

Onboard Floppy Controller Set this option to *Enabled* to enable the floppy drive controller on the motherboard. The settings are *Auto* (*AMIBIOS automatically determines if the floppy controller should be enabled*), *Enabled*, or *Disabled*. The Optimal and Fail-Safe default settings are *Enabled*.

Onboard Primary/Secondary IDE This option specifies the IDE channels on the onboard IDE controller that will be used. The settings are *Disabled*, *Primary*, *Secondary*, or *Both*. The Optimal and Fail-Safe default settings are *Disabled*.

Onboard IDE Bus Master Set this option to *Enabled* to specify that the IDE controller on the PCI local bus includes a bus mastering capability. The settings are *Enabled* or *Disabled*. The Optimal and Fail-Safe default settings are *Disabled*.

Cont'd

Offboard PCI/ISA IDE Card This option specifies if an offboard PCI IDE controller adapter card is installed in the computer. You must choose *ISA* if an ISA IDE card is installed or the PCI expansion slot on the motherboard where the offboard PCI IDE controller is installed. If an offboard ISA or PCI IDE controller is used, the onboard IDE controller is automatically disabled. The settings are *Auto* (*AMIBIOS* automatically determines where the offboard PCI IDE controller adapter card is installed), *Absent*, *ISA*, *Slot1*, *Slot2*, *Slot3*, or *Slot4*. The Optimal And Fail-Safe default settings are *Auto*.

In the AMIBIOS for the Intel Triton II ISA chipset, this option forces IRQ14 and IRQ15 to a PCI slot on the PCI local bus. This is necessary to support non-compliant ISA IDE controller adapter cards.

If an offboard PCI IDE controller adapter card is installed in the computer, you must also set the **Offboard PCI IDE Primary IRQ** and **Offboard PCI IDE Secondary IRQ** options.

Offboard Primary/Secondary This option specifies the IDE controller channels used by the offboard IDE adapter card. The settings are *Disabled*, *Primary*, *Secondary*, or *Both*. There are no Optimal and Fail-Safe default settings.

Offboard PCI IDE Primary IRQ

Offboard PCI IDE Secondary IRQ These options specify the PCI interrupt used by the primary or secondary IDE channel on the offboard PCI IDE controller. The settings are *Disabled*, *Hardwired*, *INTA*, *INTB*, *INTC*, or *INTD*. The Optimal and Fail-Safe default settings are *Disabled*.

Serial Port1 IRQ This option specifies the IRQ used for serial port1. The settings are *IRQ4* or *Disabled*. The Optimal default setting is *IRQ4*. The Fail-Safe default setting is *Disabled*.

Cont'd

Peripheral Setup, Continued

Serial Port1 Address This option specifies the base I/O port address of serial port 1. The settings are *Auto* (*AMIBIOS automatically determines the correct base I/O port address*), *Disabled*, *3F8h*, or *3E8h*. The Optimal default setting is *3F8h*. The Fail-Safe default setting is *Disabled*.

Serial Port2 IRQ This option specifies the IRQ used for serial port2. The settings are *IRQ3* or *Disabled*. The Optimal default setting is *IRQ3*. The Fail-Safe default setting is *Disabled*.

Serial Port2 Address This option specifies the base I/O port address of serial port 2. The settings are *Auto* (*AMIBIOS automatically determines the correct base I/O port address*), *Disabled*, *2F8h*, or *2E8h*. The Optimal default setting is *3F8h*. The Fail-Safe default setting is *Disabled*.

Parallel Port IRQ This option specifies the IRQ used by the parallel port. The settings are *Disabled*, *IRQ 5*, or *IRQ 7*. The Optimal default setting is *IRQ 7*. The Fail-Safe default setting is *Disabled*.

Parallel Port Address This option specifies the base I/O port address of the parallel port on the motherboard. The settings are *Disabled*, *378h*, *278h*, or *3BCh*. The Optimal default setting is *378h*. The Fail-Safe default setting is *Disabled*.

Cont'd

Peripheral Setup, Continued

Parallel Port Mode This option specifies the parallel port mode. The Optimal default setting is *Normal*. The Fail-Safe default setting is *Disabled*. The settings are:

Setting	Description
<i>Normal</i>	The normal parallel port mode is used.
<i>Bi-Dir</i>	Use this setting to support bidirectional transfers on the parallel port.
<i>EPP</i>	The parallel port can be used with devices that adhere to the Enhanced Parallel Port (EPP) specification. EPP uses the existing parallel port signals to provide asymmetric bidirectional data transfer driven by the host device.
<i>ECP</i>	The parallel port can be used with devices that adhere to the Extended Capabilities Port (ECP) specification. ECP uses the DMA protocol to achieve data transfer rates up to 2.5 Megabits per second. ECP provides symmetric bidirectional communication.

EPP Version This option specifies the Enhanced Parallel Port specification version number that is used if the **Parallel Port Mode** option is set to *EPP*. *This option can only be selected if the Parallel Port Mode option is set to EPP*

The settings are *1.7* or *1.9*. There are no Optimal and Fail-Safe default settings because the default setting for the **Parallel Port Mode** option is not *EPP*.

Parallel Port DMA Channel This option is only available if the setting for the **Parallel Port Mode** option is *ECP*. This option sets the DMA channel used by the parallel port. The settings are (*DMA Channel 1* or *3*). The Optimal and Fail-Safe default settings are *3*.

Section 2 Security

Three icons appear in this part of the WINBIOS Setup screen:

- Supervisor (Password),
 - User (Password), and
 - Anti-Virus (see page 63).
-

Two Levels of Passwords Both the Supervisor and the User icons configure password support. If you use both, the Supervisor password must be set first.

The system can be configured so that all users must enter a password every time the system boots or when WINBIOS Setup is executed, using either or both the Supervisor password or User password.

AMIBIOS Password Support

The Supervisor and User icons activate two different levels of password security.

If WINBIOS Setup has an optional password feature. The system can be configured so that all users must enter a password every time the system boots or when WINBIOS Setup is executed.

Setting a Password

The password check option is enabled in Advanced Setup (see the Advanced Setup section) by choosing either *Always* (the password prompt appears every time the system is powered on) or *Setup* (the password prompt appears only when WINBIOS is run). The password is encrypted and stored in NVRAM.

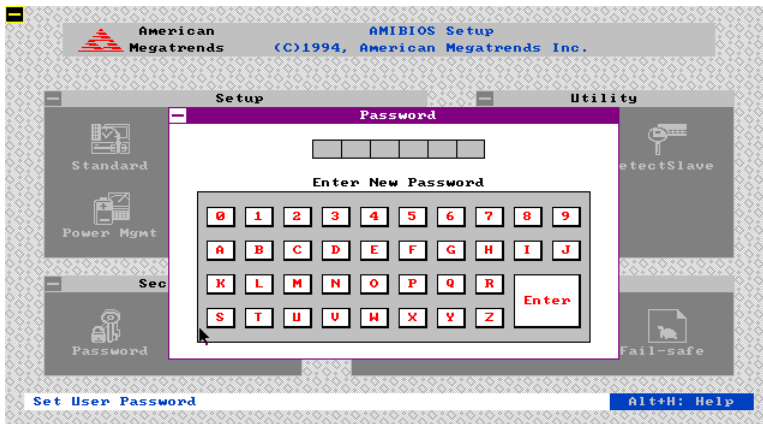

As shown on the above screen, you are prompted for a 1 – 6 character password. You can either type the password on the keyboard or select each letter of the password, one at a time, using the mouse. The password does not appear on the screen when typed. Make sure you write it down. If you forget it, you must drain NVRAM and reconfigure.

If You Do Not Want to Use a Password Just press <Enter> when the password prompt appears.

Changing a Password

Select the *Supervisor* or *User* icon from the Security section of the WINBIOS Setup main menu. Enter the password and press <Enter>. The screen does not display the characters entered. After the new password is entered, retype the new password as prompted and press <Enter>.

If the password confirmation is incorrect, an error message appears. If the new password is entered without error, press <Esc>. The password is stored in NVRAM after WINBIOS completes. The next time the system boots, a password prompt appears if the password function is present and enabled.

Remember the Password Keep a record of the new password when the password is changed. If you forget the password, you must erase the system configuration information in NVRAM (Non-Volatile Random Access Memory). See page 21 for information about erasing system configuration information.

Anti-Virus

When this icon is selected from the Security section of the WINBIOS Setup main menu, AMIBIOS issues a warning when any program (or virus) issues a Disk Format command or attempts to write to the boot sector of the hard disk drive. The settings are *Enabled* or *Disabled*. If enabled, the following appears when a write is attempted to the boot sector. You may have to type *N* several times to prevent the boot sector write.

```
Boot Sector Write!!!  
Possible VIRUS: Continue (Y/N)? _
```

The following appears after any attempt to format any cylinder, head, or sector of any hard disk drive via the BIOS INT 13 Hard Disk Drive Service:

```
Format!!!  
Possible VIRUS: Continue (Y/N)? _
```

Section 3 Utility

The following icons appear in this section of the WINBIOS Setup main screen:

Color Set	Color Set sets the Setup screen colors.
Language	If this feature is enabled, you can select WINBIOS Setup messages in different languages.

Section 4 Default

The icons in this section permit you to select a group of settings for all WINBIOS Setup options. Not only can you use these icons to quickly set system configuration parameters, you can choose a group of settings that have a better chance of working when the system is having configuration-related problems.

Original	Choose the Original icon to return to the system configuration values present in WINBIOS Setup when you first began this WINBIOS Setup session.
Optimal	You can load the optimal default settings for the WINBIOS by selecting the Optimal icon. The Optimal default settings are best-case values that should optimize system performance. If NVRAM is corrupted, the Optimal settings are loaded automatically.
Fail-Safe	<p>You can load the Fail-Safe WINBIOS Setup option settings by selecting the Fail-Safe icon from the Default section of the WINBIOS Setup main menu.</p> <p>The Fail-Safe settings provide far from optimal system performance, but are the most stable settings. Use this option as a diagnostic aid if the system is behaving erratically.</p>

3 Programming the Flash ROM

All versions of the Atlas PCI-III motherboard use Flash EPROM to store the system BIOS. The advantage of Flash EPROM is the EPROM chip does not have to be replaced to update the BIOS. The end user can actually reprogram the BIOS, using a ROM file supplied by American Megatrends.

Programming the Flash EPROM

Step	Action
1	Turn power off. Make sure the computer has a working speaker.
2	Insert the floppy disk with the S757P.ROM file in drive A:.
3	Before DOS boots, press and hold down the <Ctrl> and <Home> keys to reprogram the Flash EPROM-based AMIBIOS. The bootblock code immediately reads the A: drive, looking for the new BIOS information.
4	When the flash ROM has successfully been programmed, the computer will reboot.

Bootblock BIOS Actions When you reprogram from system boot, the bootblock BIOS code:

Reads S757P.ROM from the root directory of the floppy disk in drive A:.

Erases the Flash EPROM.

Programs the Flash EPROM with the data read from the floppy disk in drive A:.

Generates a CPU reset, rebooting the computer.

The bootblock part of the Flash EPROM is not programmed. Should you inadvertently open the disk drive door or turn power off to the computer while programming the Flash EPROM, the bootblock will be unaffected. Simply turn power back on and begin the Flash ROM programming process again.

Cont'd

Programming the Flash ROM, Continued

S757P.ROM S757P.ROM resides on a floppy disk and contains the updated main BIOS code. American Megatrends will provide this file when the AMIBIOS for the Atlas PCI-III ISA motherboard must be updated.

S757P.ROM must be present in the root directory of the floppy disk before the onboard Flash EPROM can be reprogrammed. The file that has the main BIOS code must be named S757P.ROM.

Sequence of Operation The sequence of operation and expected behavior of the bootblock BIOS code is:

Step	Expected behavior
1 Look for floppy disk.	The system beeps one time before the BIOS attempts to read from floppy drive A:.
2 Look for S757P.ROM on the floppy disk.	S757P.ROM must be in the root directory of the floppy disk in drive A:. There is no beep if successful.
3 Read the floppy disk.	The floppy disk is read. There is no beep if this step is successful.
4 Check for BIOS file size.	The BIOS file size is checked. There is no beep if this step is successful.
5 Check for Flash EPROM.	The BIOS looks for an Intel i28F001BX-T Flash EPROM. It does not beep if this step is successful.
6 Erase the Flash EPROM.	Two beeps sound when the BIOS begins erasing the Flash EPROM.
7 Program the Flash EPROM.	Three beeps sound when the AMIFlash Code begins reprogramming the Flash EPROM.
8 Continue programming the Flash EPROM.	Four beeps sound when reprogramming has been successfully completed.
9 AMIFlash does a reset.	A CPU reset is generated to reboot the computer.

Programming the Flash ROM, Continued

Beep Codes The bootblock code produces a series of beeps during Flash ROM programming to:

- signify completion of a step (as shown on the previous page), or to
- signal an error.

Error beeps are arranged in a coded sequence and have different meanings depending on when they occur. The error beep codes and when they can occur are:

Number of Beeps	Description
1	Insert diskette in floppy drive A:.
2	The AMIBOOT.ROM file was not found in the root directory of the diskette in floppy drive A:.
3	Base memory error.
4	Flash program successful.
5	Floppy read error.
6	Keyboard controller BAT command failed.
7	No Flash EPROM detected.
8	Floppy controller failure.
9	Boot Block BIOS checksum error.
10	Flash erase error.
11	Flash program error.
12	AMIBOOT.ROM file size error.
Continuous beep	Flash Programming successful. Turn power off. The turn power on again to restart.

Bootblock Code Checkpoint Codes

Code	Description
E0h	Verify the bootblock BIOS checksum. Disable the internal cache, DMA, and interrupt controllers. Initialize the system timer. Start memory refresh.
E1h	Initialize the chipset registers. Set the BIOS size to 128K. Make the 512 KB base memory available.
E2h	Test the base 64 KB of system memory. Send the BAT command to the keyboard controller. Make sure that <Ctrl> <Home> was pressed. Verify the main system BIOS checksum.
E3h	The main system BIOS is good. Transfer control to the main system BIOS.
E4h	Start the memory test.
E5h	The memory test is over. Initialize the interrupt vector table.
E6h	Initialize the DMA and interrupt controllers.
E7h	Determine the CPU internal clock frequency.
E8h	Initialize the I/O chipset, if any.
E9h	Program the CPU clock-dependent chip set parameters.
EAh	Enable the timer and the floppy diskette interrupt. Enable the internal cache. Copy the bootblock BIOS and pass control to the bootblock BIOS in the 0000h segment.
EDh	Initialize the floppy drive.
EEh	Look for a diskette in drive A:.. Read the first sector of the diskette.
EFh	Floppy read error.
F0h	Search for AMIBOOT.ROM in the root directory of the floppy diskette in drive A:..
F1h	The AMIBOOT.ROM file is not in the root directory.
F2h	Read the FAT. Analyze the FAT to find the clusters occupied by the AMIBOOT.ROM.
F3h	Start reading the AMIBOOT.ROM file, cluster by cluster.
F4h	The AMIBOOT.ROM file is not the correct size.
F5h	Disable the internal cache. Raise the Vpp. Enable Flash write and reset the Flash ROM.
FBh	Detect the flash type.
FCh	Start erasing flash blocks.
FDh	Program the Flash ROM in the E0000-EFFFFh region.
FEh	Start programming Flash at F0000-FFFFF region.
FFh	Flash programming is successful. The computer reboots.

A Specifications

Item	Description
CPU	AMD K6 or Intel Pentium P54C or P55C 75, 90, 100, 120, 133, 150, 166, 180, 200 MHz or higher speed CPU
Chipset	Intel 82430HX, including CPU interface controller, advanced cache controller, integrated DRAM controller, synchronous ISA bus controller, PCI local bus interface, and integrated power management unit.
Expansion slots	Four ISA expansion slots Four PCI expansion slots
L1 internal cache memory	The Intel Pentium has 8 KB data cache and 8 KB instruction cache.
L2 secondary cache memory	256 KB or 512 KB of synchronous PBSRAM, direct-mapped, write-back.
Cache memory /system memory	256 KB caches up to 128 MB of system memory 512 KB caches up to 256 MB of system memory
Type of System Memory	Up to 256 MB mounted on the motherboard in two banks of 72-pin 4 MB, 8 MB, or 16 MB SIMMs.
System memory	Fast page mode or Extended Data Out (EDO) SIMMs operating at 70 ns.
Memory buffer	One level posted write memory buffer
Max. system memory	256 MB
Fast ATA	Supports the Fast ATA specification using PIO mode 4 and multiword DMA mode 2.
System BIOS	This motherboard has a 128 KB AMIBIOS system BIOS on a Flash ROM with built-in WINBIOS Setup.
BIOS shadowing	The system BIOS is always copied from ROM to RAM for faster execution. The end user can shadow 16 KB ROM segments from C000h – DCFFFh.
AMIBIOS features	IDE block mode support, IDE 32-bit data transfer support, IDE Programmed I/O mode 0, 1, 2, 3, and 4 support, IDE LBA mode support, APM (Advanced Power Management) and Flash BIOS hooks, EPA Green PC-compliant, PCI and Plug and Play (PnP) support, and DIM (Device Initialization Manager) support, DMI (Desktop Management Interface) support, ATAPI support, can boot from a CD-ROM drive, automatically detects system memory, cache memory, and IDE drive parameters, Intel NSP-compliant, Fast ATA IDE mode programming, Boot sector virus protection, instant-on support, automatically configures PnP and PCI devices.
IDE	Provides two 40-pin IDE connectors onboard that support up to four IDE drives. IDE controller is on the PCI local bus.
Floppy	Onboard support for up to two 360 KB, 720 KB, 1.2 MB, 1.44 MB, or 2.88 MB floppy drives.
Parallel port	Onboard ECP and EPP-capable parallel port connector.
Serial ports	Two onboard serial port connectors. Two 16550 UART serial ports.
Keyboard	Includes a standard miniDIN keyboard connectors.
USB	Two USB connectors are provided on the motherboard.
Mouse	Includes a 10-pin berg mouse connector and an optional PS/2 mouse miniDIN connector.

Item	Description
Power supply	Includes three power supply connectors.
Real time clock/ CMOS RAM	A real time clock and 128 bytes of CMOS RAM with a battery backup is provided on the motherboard.
Power management	Power management services include: Green PC LED, power management signal to Green PC-aware power supplies, automatic IDE and video power down, monitor blanking, SMI (System Management Interrupt) support, APM, and system stop clock.
Speaker	Standard four-pin speaker connection.

Index

3

32-bit data transfer support, 69

A

Advanced Setup, 44
Allocate IRQ to PCI VGA, 53
AMIBIOS features, 69
AMIFlash
 Beep Codes, 67
Anti-Virus
 WINBIOS Setup, 63
ATAPI support, 69

B

BIOS

Password Support, 61
 BIOS Defaults, 64
 BIOS Errors, 35
 BIOS Security, 61
 BIOS shadowing, 69
 BIOS Utility, 64
Block mode support, 69
Boot sector virus protection, 69
Boot To OS/2, 45
Boot Up Num Lock, 45
Boot Up Sequence, 45

C

Cables
 Connecting, 20, 24
Cache Memory
 Configuring, 18
CD-ROM drive
 booting from, 69
 Configuring, 41
Chipset, 69
CN4 Mouse connector, 23
CN6 Pinout, 22
Color Set, 64
COM1, 27
COM2, 27
Configuring System, 35
Conflicts, 27
Connectors, 20
 Floppy disk, 29
 IDE Activity Indicator, 26
 IDE Hard Disk Drive, 32
 Keyboard, 23
 Serial ports, 27
 SIMM, 17
 Speaker, 25
CPS Clear Password, 21
CPU, 69
 Configuring, 10
 Installing, 13

D

Desktop Management Interface, 69
Device Initialization Manager, 69
DIM, 69
Display Activity, 51
DMA Channel 0, 56
DMA Channel 1, 56
DMA Channel 3, 56
DMA Channel 5, 56
DMA Channel 6, 56
DMA Channel 7, 56
DMI, 69
DRAM Configurations, 16
DRAM Data Integrity Mode, 48

E

EPP Version, 60
Expansion slots, 69
External Cache, 46
External SMI, 14

F

Fail-Safe BIOS Setup Settings
 WINBIOS Setup, 64
Fast ATA, 69
Fast ATA IDE mode programming, 69
Figures
 Floppy drive cable, 29
 Floppy drive connector, 29
 Power supply key cutting, 22
 Reset switch connector, 25
 Speaker connector, 25
Flash EPROM
 Programming, 65
Floppy Disk Connector
 Pinout, 29
Floppy Drive connector
 Pinout, 30
Floppy Drive Swap, 45

G

Green PC, 69
Green PC Monitor Power State, 49

H

Hard Disk Drive Capacity, 42
Hard Disk Drive Parameters, 42
Hard Disk Drive Type D:, 41
Hard Disk Power Down Mode, 50
Hard Disk Timeout (Minute), 50

I

IDE Activity Indicator LED, 26

IDE drive

Configuring, 41

IDE Drive connectors, 31

IDE Hard Disk Connector, 32

Install Memory, 15

Installation, 6

Installing Adapter Cards, 35

Installing the Motherboard, 19

Instant-on support, 69

Instant-On Timeout (Minute), 49

Intel 82430HX, 69

IRQ10, 52, 55

IRQ11, 52, 55

IRQ12, 52, 55

IRQ12/M Mouse Function, 48

IRQ13, 52

IRQ14, 52, 55

IRQ15, 52, 55

IRQ3, 52, 55

IRQ4, 52, 55

IRQ5, 52, 55

IRQ7, 52, 55

IRQ9, 52, 55

J

J13 CPU Fan, 24

J19 PS/2 Mouse IRQ, 25

J2 Enable External SMI, 14

J20 IDE Indicator LED, 26

J23 Speaker Connector, 25

J24 Keyboard Lock connector, 26

J3 Enable Refresh, 14

J4 Enable PCI SERR# Signal, 14

J5, J6, J7, and J8, 10

K

Keyboard, 44

Keyboard Cable, 23

Keyboard connector, 23

L

L1 internal cache memory, 69

L2 secondary cache memory, 69

Landing Zone, 42

Language, 64

LBA mode, 69

M

Memory

Reporting, 15

Memory Hole, 48

Monitor, 44

Motherboard Size, 2

Mouse Support, 25, 44

N

NSP, 69

Number of Cylinders, 42

Number of Heads, 42

Number of Sectorss, 42

O

Offboard PCI IDE Primary IRQ, 58

Offboard PCI IDE Secondary IRQ, 58

Offboard PCI/ISA IDE Card, 58

Offboard Primary/Secondary, 58

Onboard Adapters, 27

Onboard Floppy Controller, 57

Onboard I/O, 5

Onboard IDE Bus Master, 57

Onboard Primary/Secondary IDE, 57

Optimal default settings

WINBIOS Setup, 64

Original, 64

Overview, 1

P

P3 floppy connector, 29

P4 Parallel Port connector, 28

P5 Pinout, 33

P9 Pinout, 34

P9 Secondary IDE Controller, 33

Parallel Port, 28

Parallel Port Address, 59

Parallel Port DMA Channel, 60

Parallel Port Mode, 60

Password Check, 45

Password Support

Levels of, 61

Pause on Config. Screen, 44

PCI Slot-1 IRQ Preference, 54

PCI Slot-1 Latency Timer, 53

PCI Slot-2 IRQ Preference, 54

PCI Slot-2 Latency Timer, 53

PCI Slot-3 IRQ Preference, 54

PCI Slot-3 Latency Timer, 53

PCI Slot-4 IRQ Preference, 54

PCI Slot-4 Latency Timer, 53

PCI specification, 5

PCI/PnP Setup, 53

Pentium, 69

Peripheral Setup, 57

Onboard IDE, 31

Pinout

P9 Secondary IDE connector, 34

Parallel Port, 28

Serial ports, 27

Pinouts

IDE Activity Indicator, 26

Keyboard lock, 26

Reset Switch, 25

Serial ports, 27

Plug and Play-Aware OS, 53

Power management, 70

Power Management Setup, 49

Power Management/APM, 49

Power Supply, 21

Pinouts, 22

Pri Master, Pri Slave, Sec Master, Sec Slave, 41

Primary Display, 44

Programmed I/O mode, 69

PS/2 Mouse IRQ, 25

PS/2 mouse support, 44

PS/2Mouse Support, 44

PS/2-type mouse, 23

R

Real time clock/, 70
Refresh, 14
Reporting Memory, 15
Reserved ISA Card Memory Address, 56
Reserved ISA Card Memory Size, 56
Reset Switch Connector, 25
Resource conflicts, 27

S

S757P.ROM, 66
S757P.ROM file, 65
SCSI drive
 Configuring, 41
Serial port
 Pinout, 27
Serial Port1 Address, 59
Serial Port1 IRQ, 58, 59
Serial Port2 Address, 59
Serial Port2 IRQ, 59
Shadow C800,16K, 47
Shadow CC00,16K, 47
Shadow D000,16K, 47
Shadow D400,16K, 47
Shadow D800,16K, 47
Shadow DC00,16K, 47
SIMM Part Numbers, 15
SIMMs
 Installing, 17
 Part numbers, 15
Size, 2
Slow Clock Ratio, 51
Speaker, 70
Speaker Cable Connector, 25
Specifications, 69
Standard Setup, 40
Standby Timeout (Minute), 50
Static Electricity, 9
Supervisor Password, 61
Suspend Timeout (Minute), 50
System BIOS, 69
System Keyboard, 44
System Memory, 69
 Configuring, 15
System memory configurations, 16
System Using Cache Controller, 46

T

Tables
 Floppy pinout, 30
 Hard Disk Drive Types, 43
 I/O conflicts, 27
 Serial port pinout, 27
 Speaker connector pinout, 25
 Steps for installing motherboard, 19
 Twist in floppy cable, 30
Technical Support, iv
Test motherboard, 35
Testing System, 35

U

Unpack the Motherboard, 8
Index

USB, 69
USB Device IRQ Preference, 53
USB Device Latency Timer, 53
USB Function Enable, 48
USB Keyboard/Mouse Legacy Support, 48
User Password, 61

V

Video Power Down Mode, 49
Video Shadow C000,32K, 46
Virus protection, 69

W

WINBIOS Setup, 37
Write Precompensation, 42

